

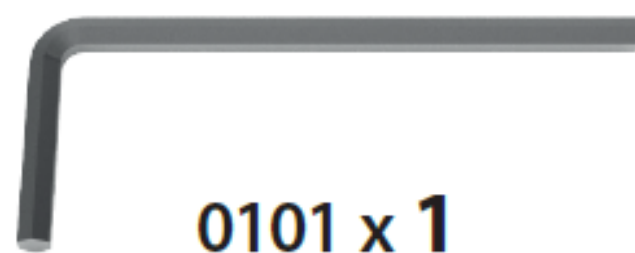

8+
815
SCRATCH
2593





0101 x 1

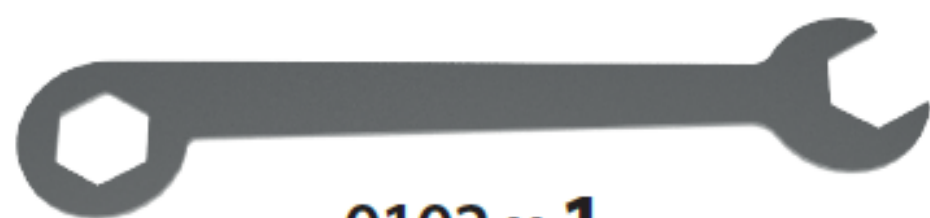

0102 x 1



1006 x 94



1007 x 85

M4 - 6mm



1001 x 63

M4 - 10mm



1002 x 10

M4 - 12mm



1003 x 8

M4 - 16mm



1004 x 6

M4 - 20mm



1005 x 6



03F1R x 4



032Z x 2



0207 x 1



0215 x 6

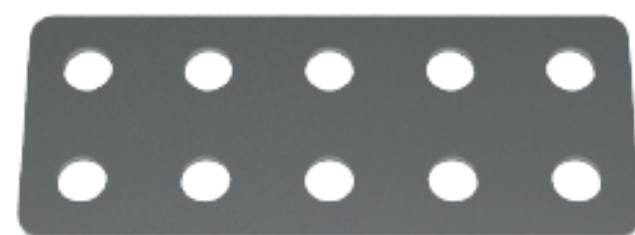

0410 x 1



04K1 x 2



032F x 1



0341 x 2



03P5R x 4



0307 x 5



0309 x 1



03P5 x 7



0512 x 2

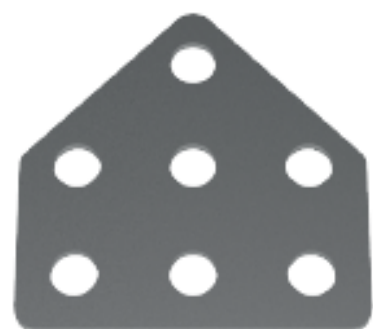

047D x 2

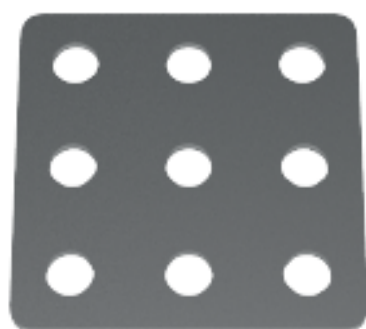

0409 x 2

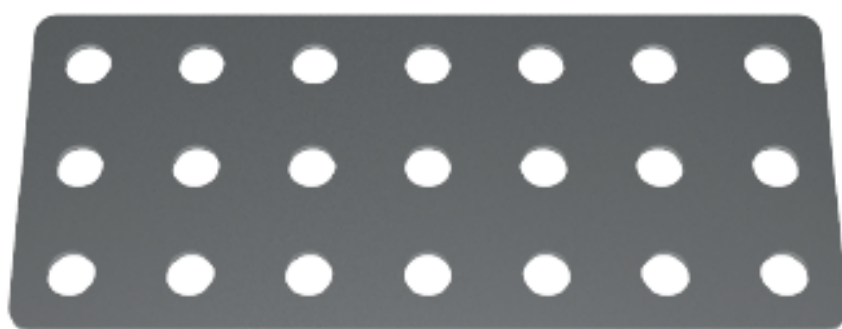

0421 x 6



0425 x 2

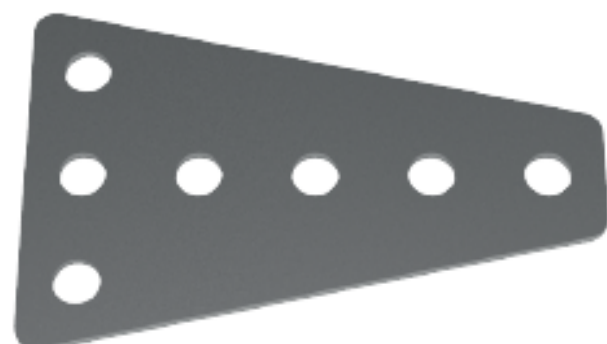

047DW x 4

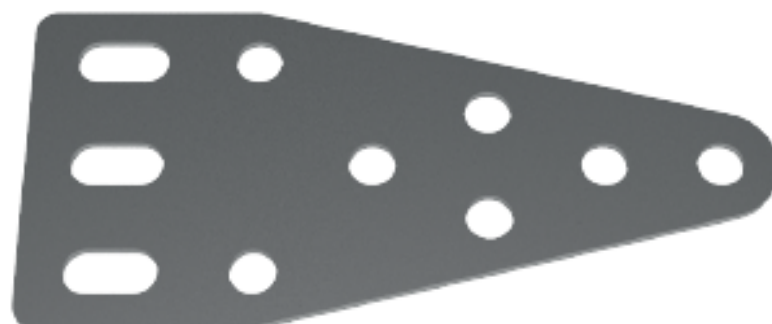

047F3 x 2



0721 x 2

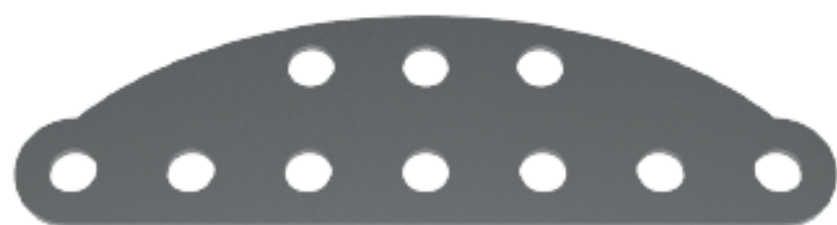

0610 x 2



0603 x 2

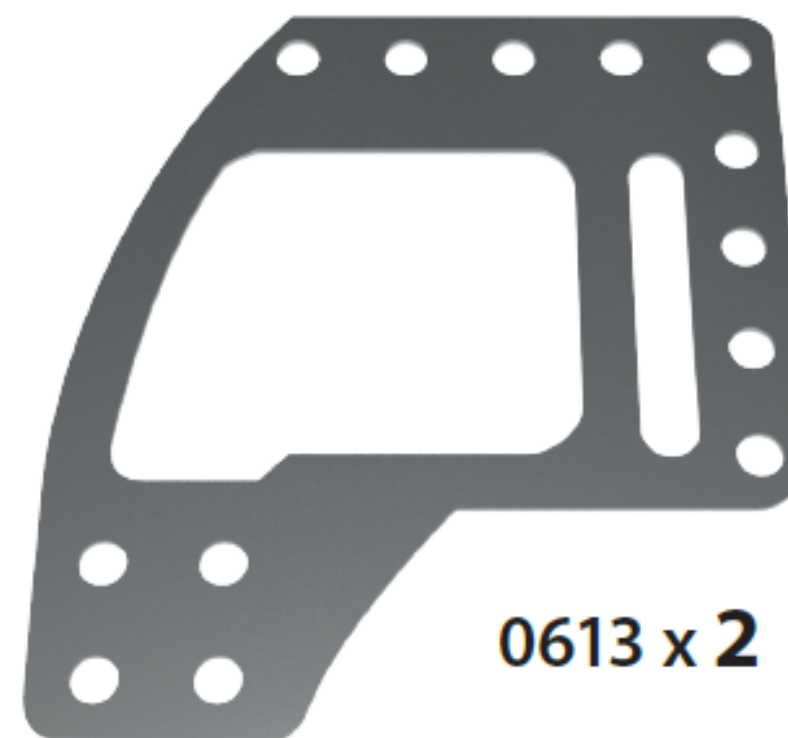

0613 x 2



0705 x 4



0716 x 4



0731 x 1



0905 x 2



0781Z x 29









0781CZ x 5



0781B x 3



0782F x 8

-  x 1
-  x 1
-  x 1
-  x 2
-  x 6
-  x 6

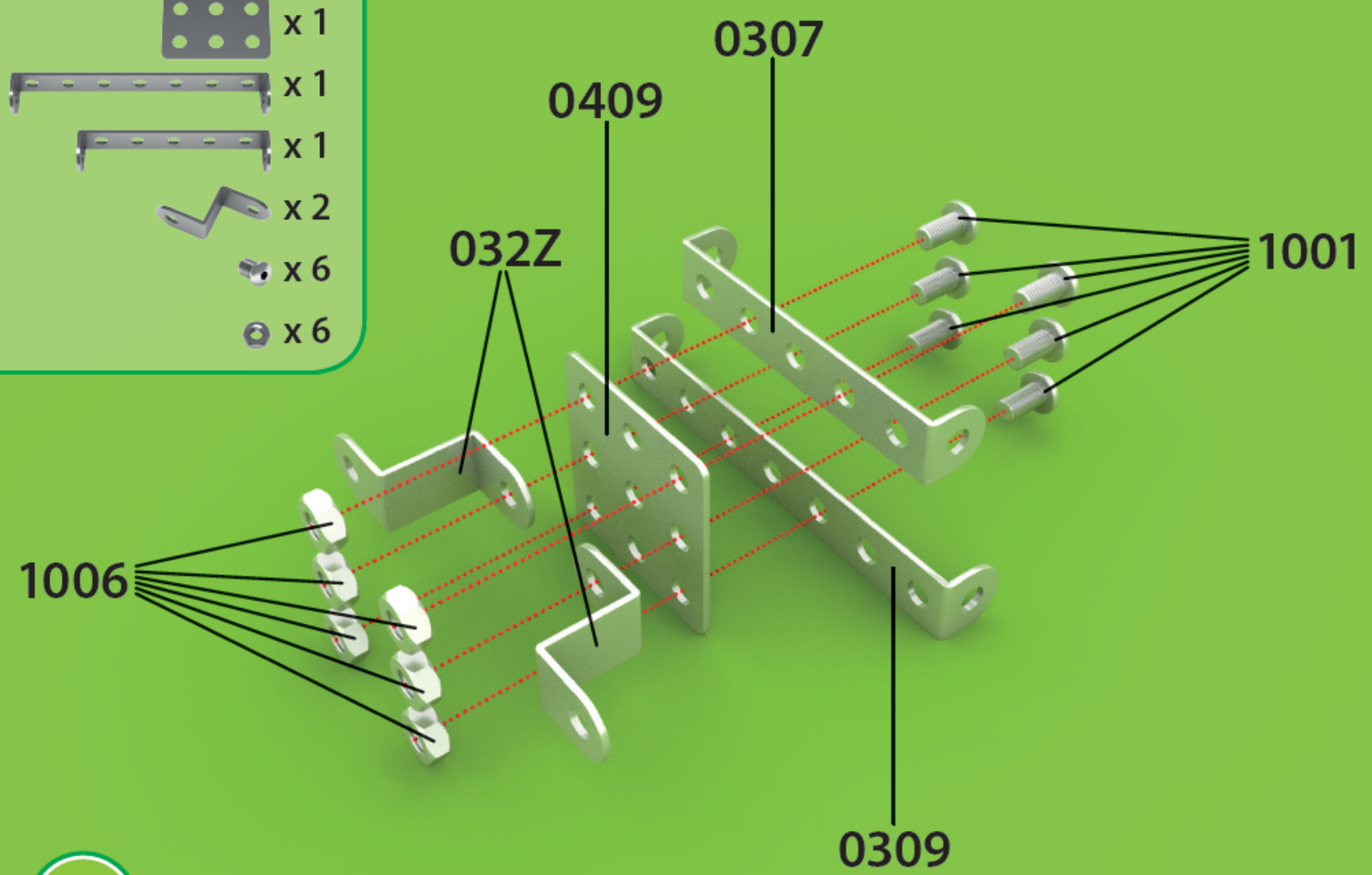

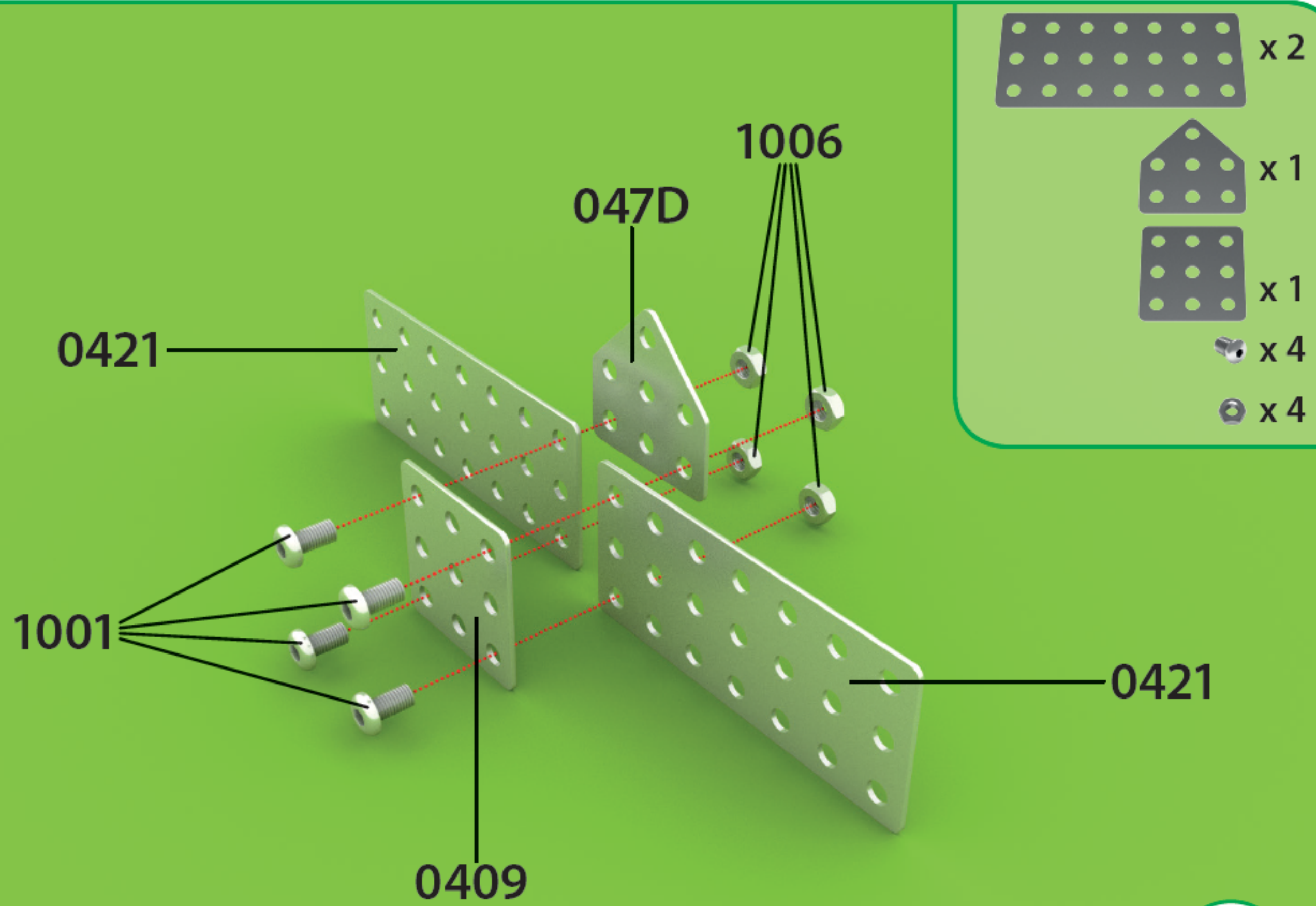



x 2



x 2



x 2

1006

047F3

047F3

1001

3

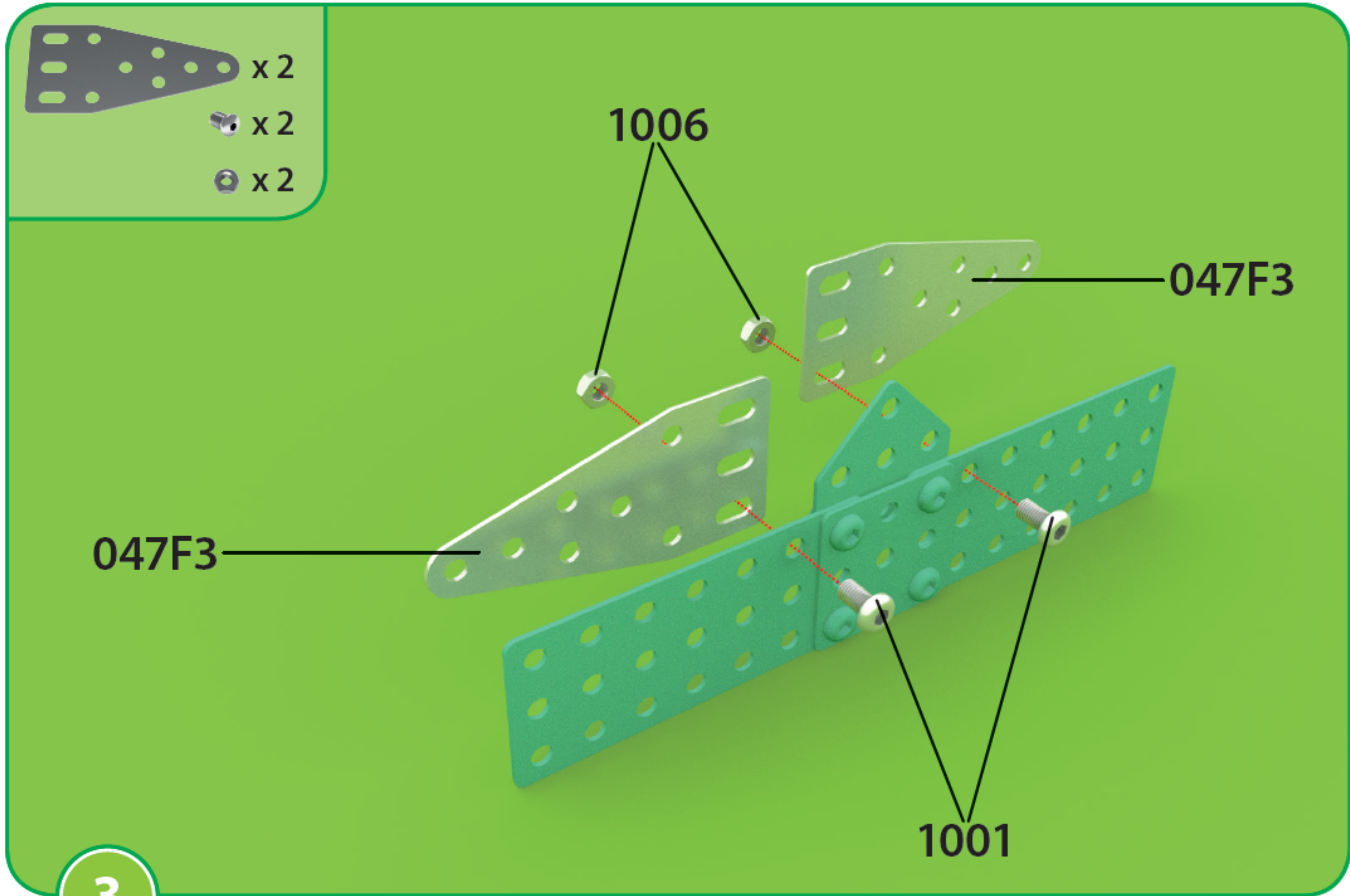

 x 2

 x 2

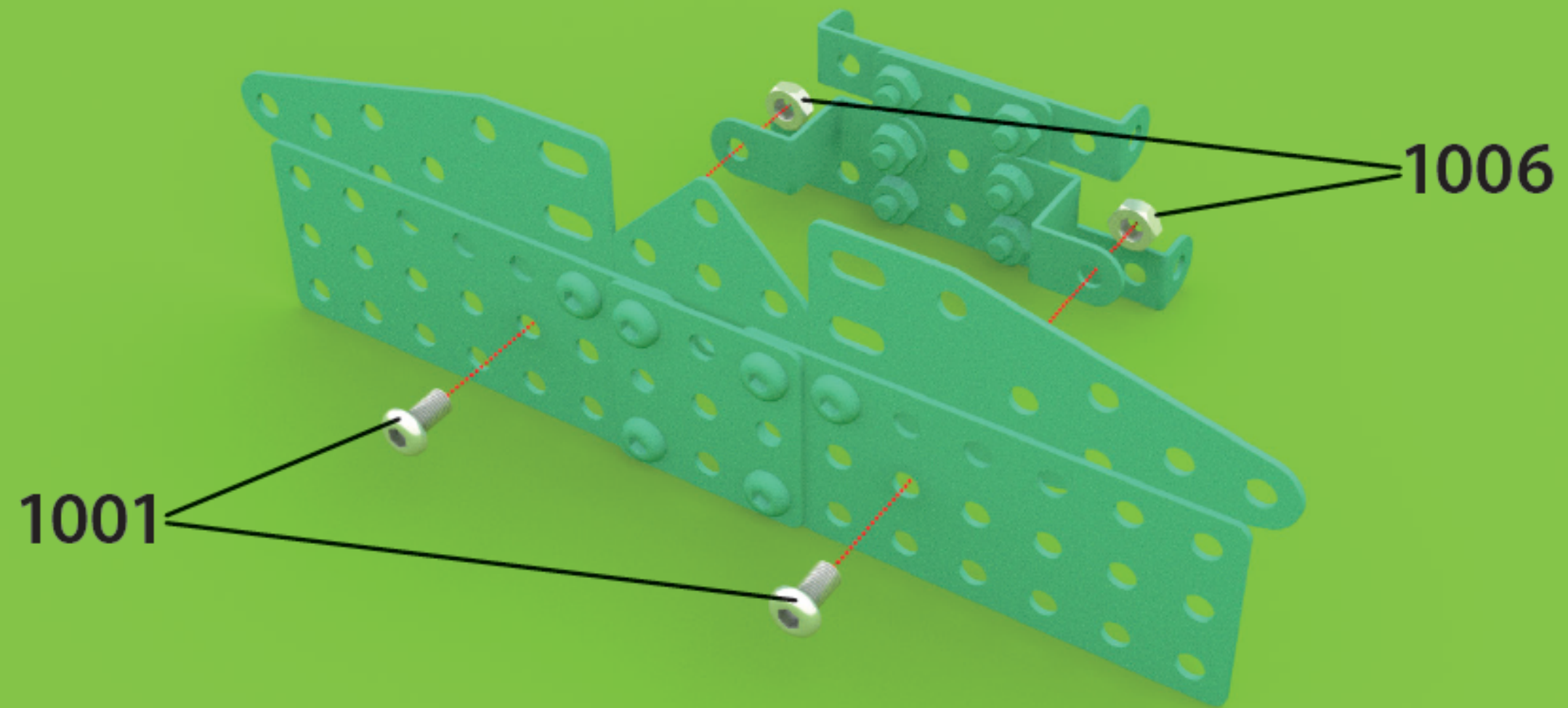

 x 4

 x 4

 x 2

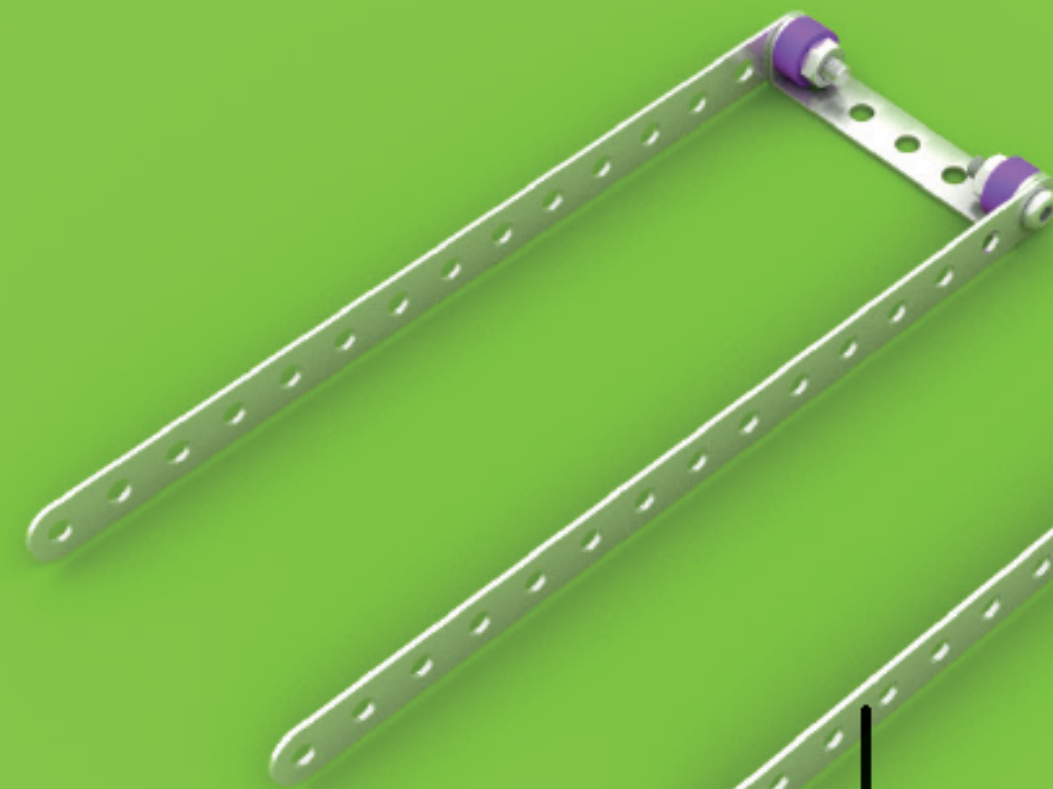

 x 4

 x 4



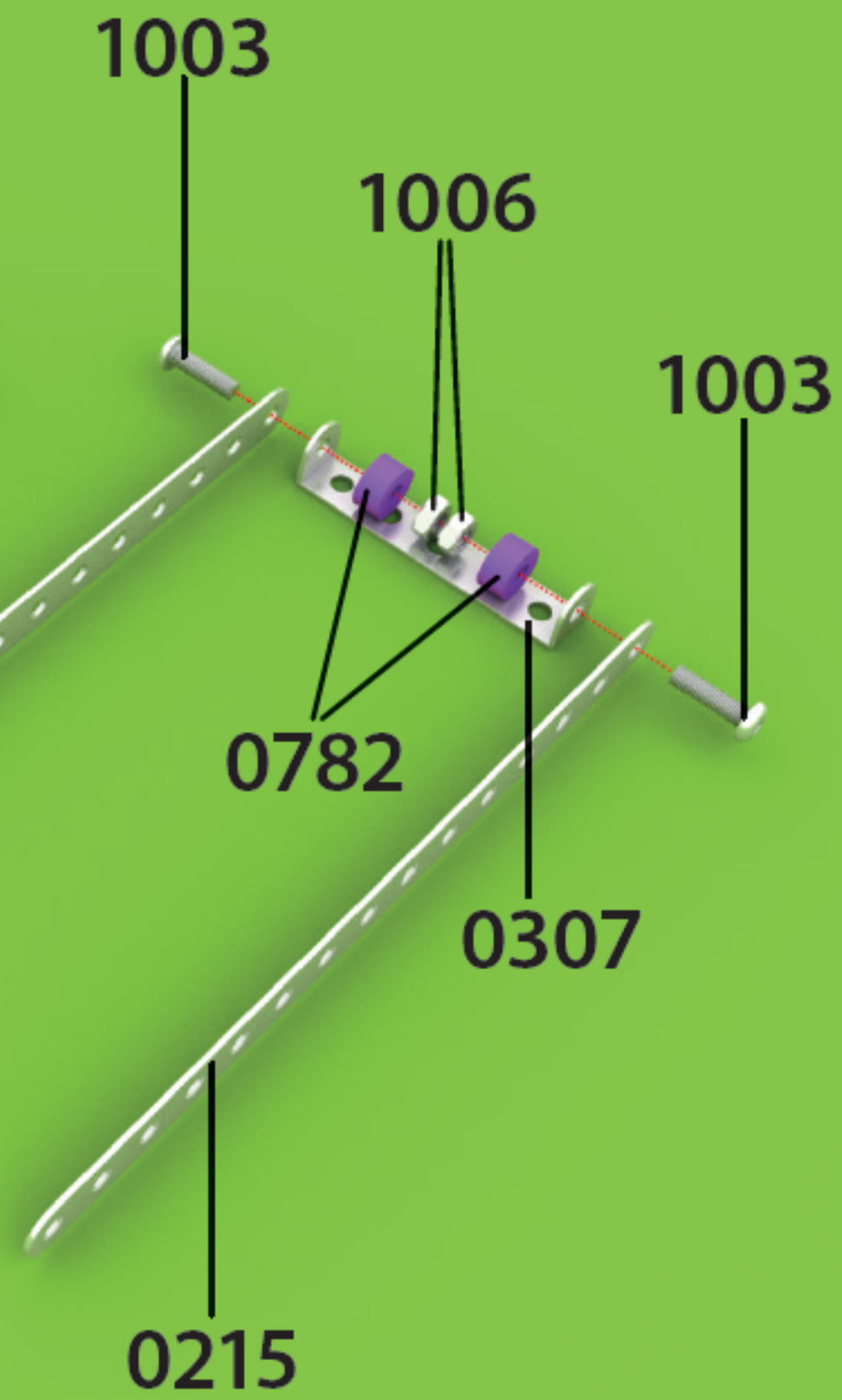

0215

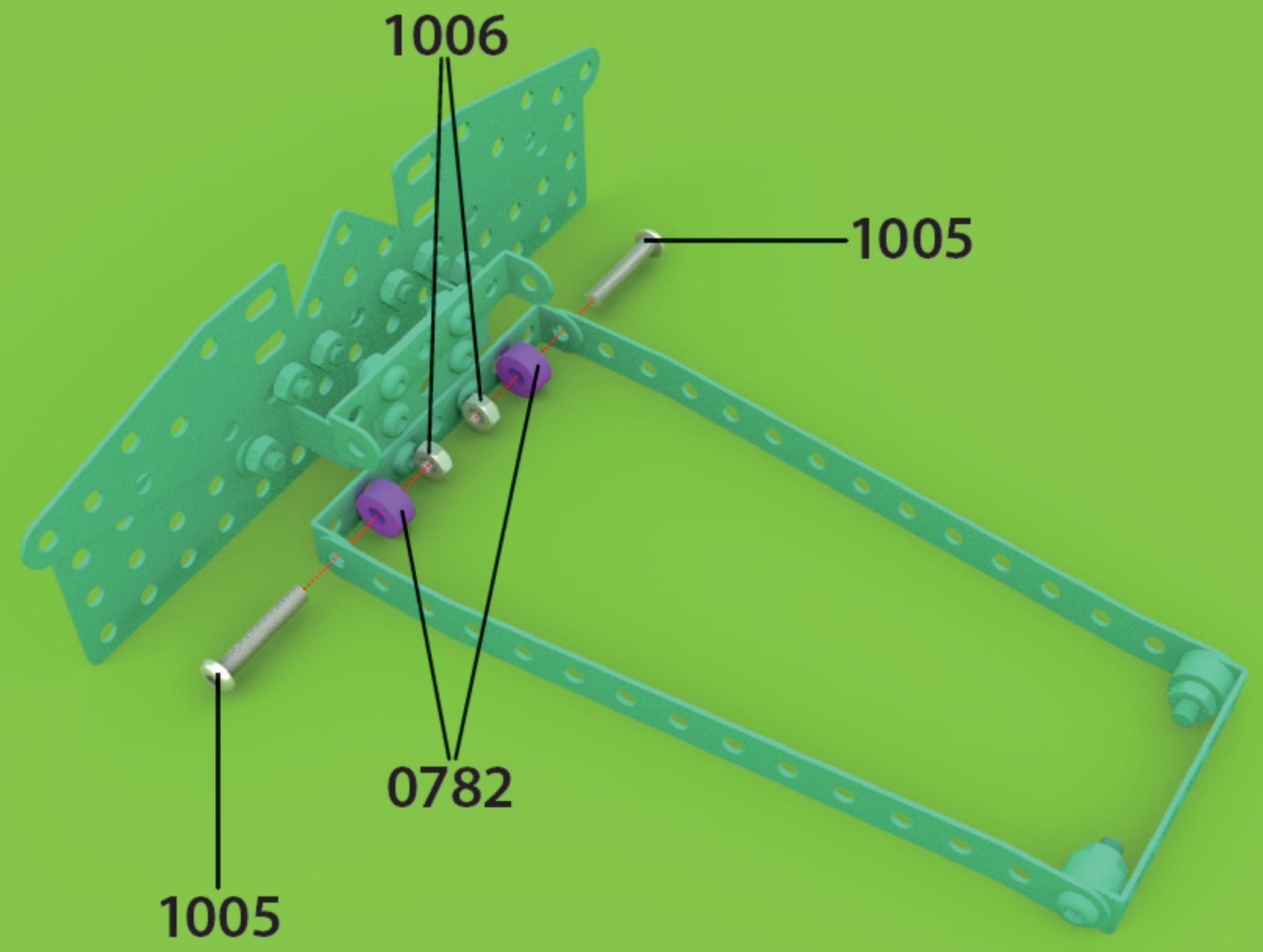

-  x 2
-  x 2
-  x 2



 x 2

 x 2

 x 2

 x 2

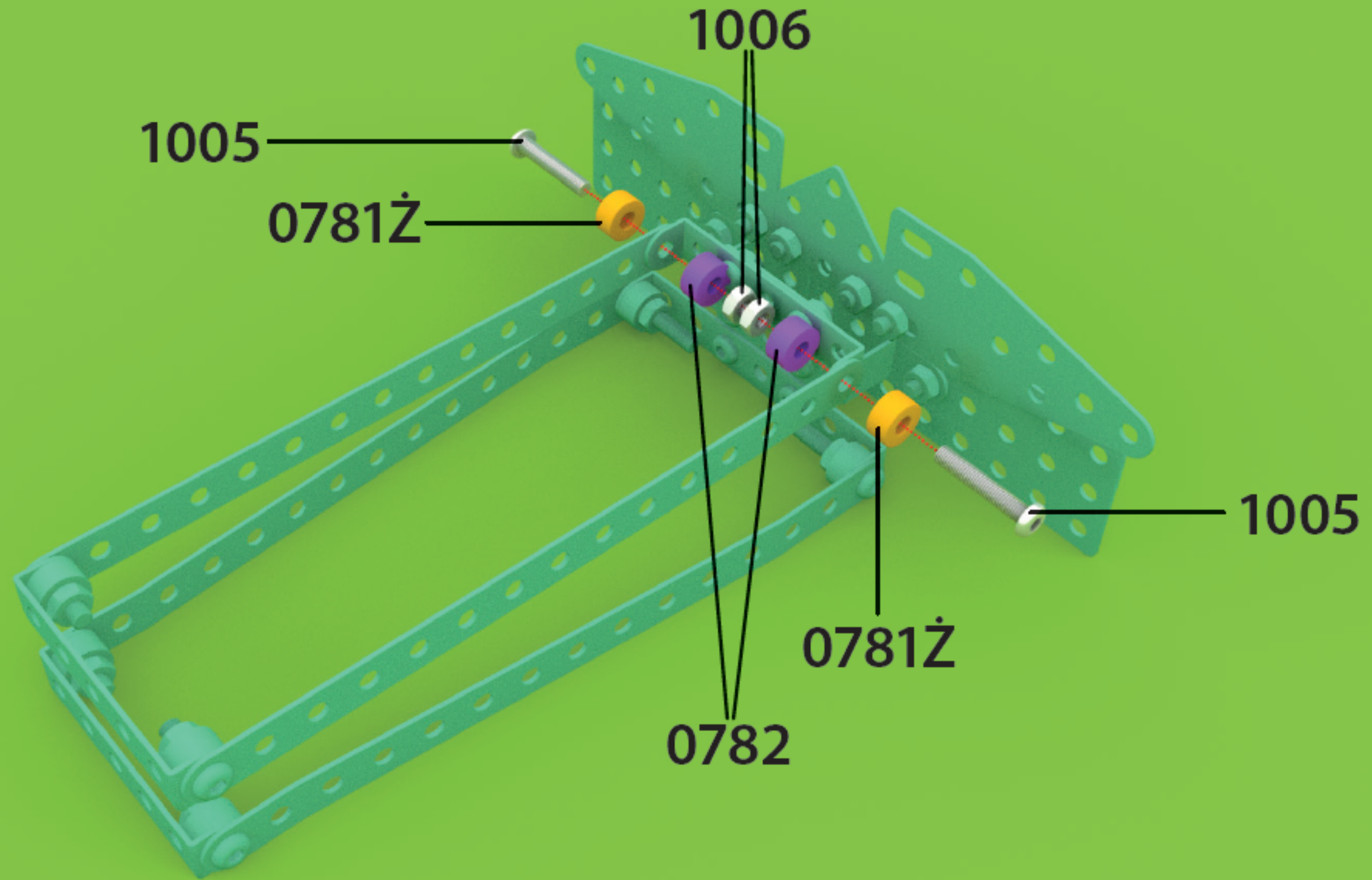

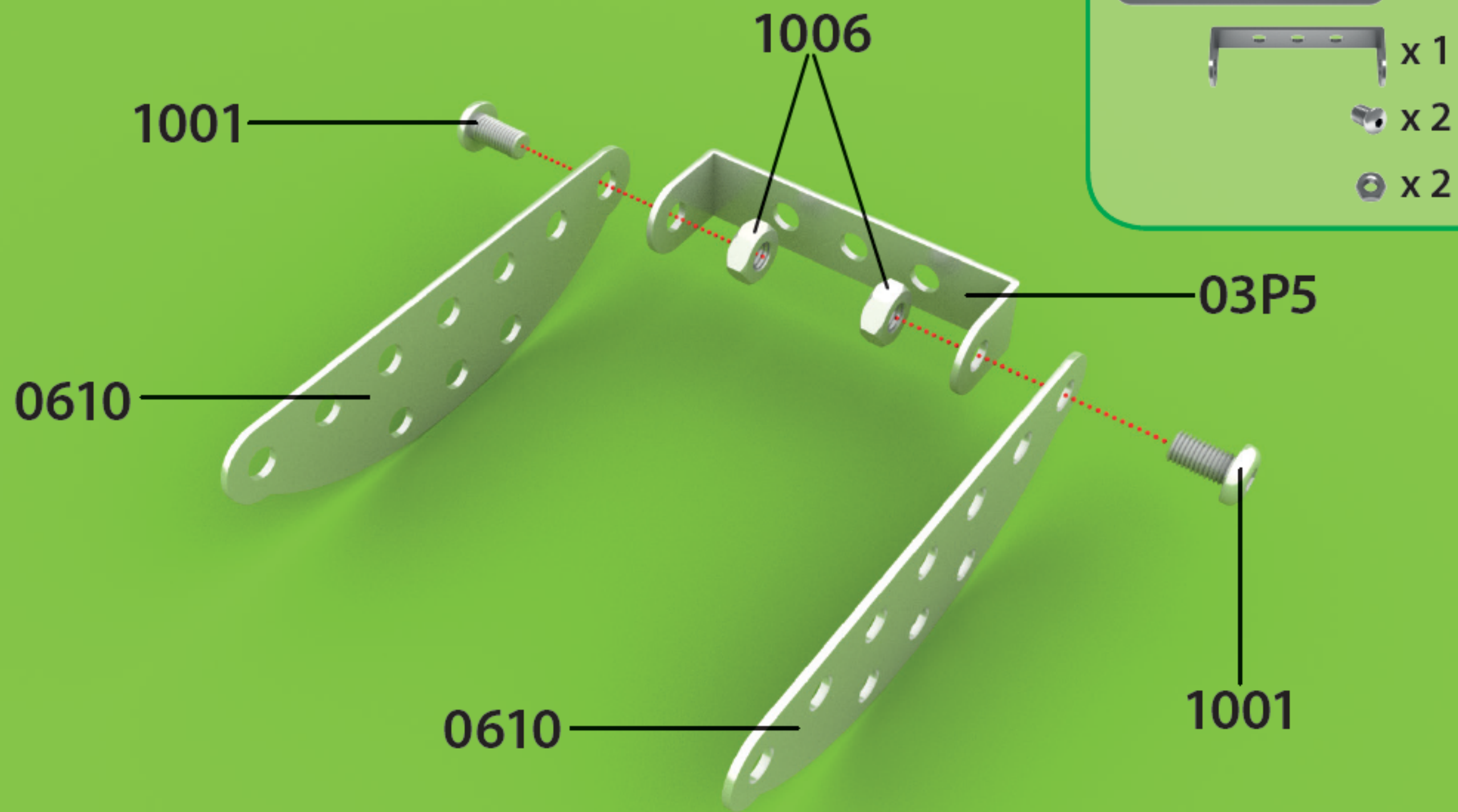



x 1



x 2



x 2



x 2

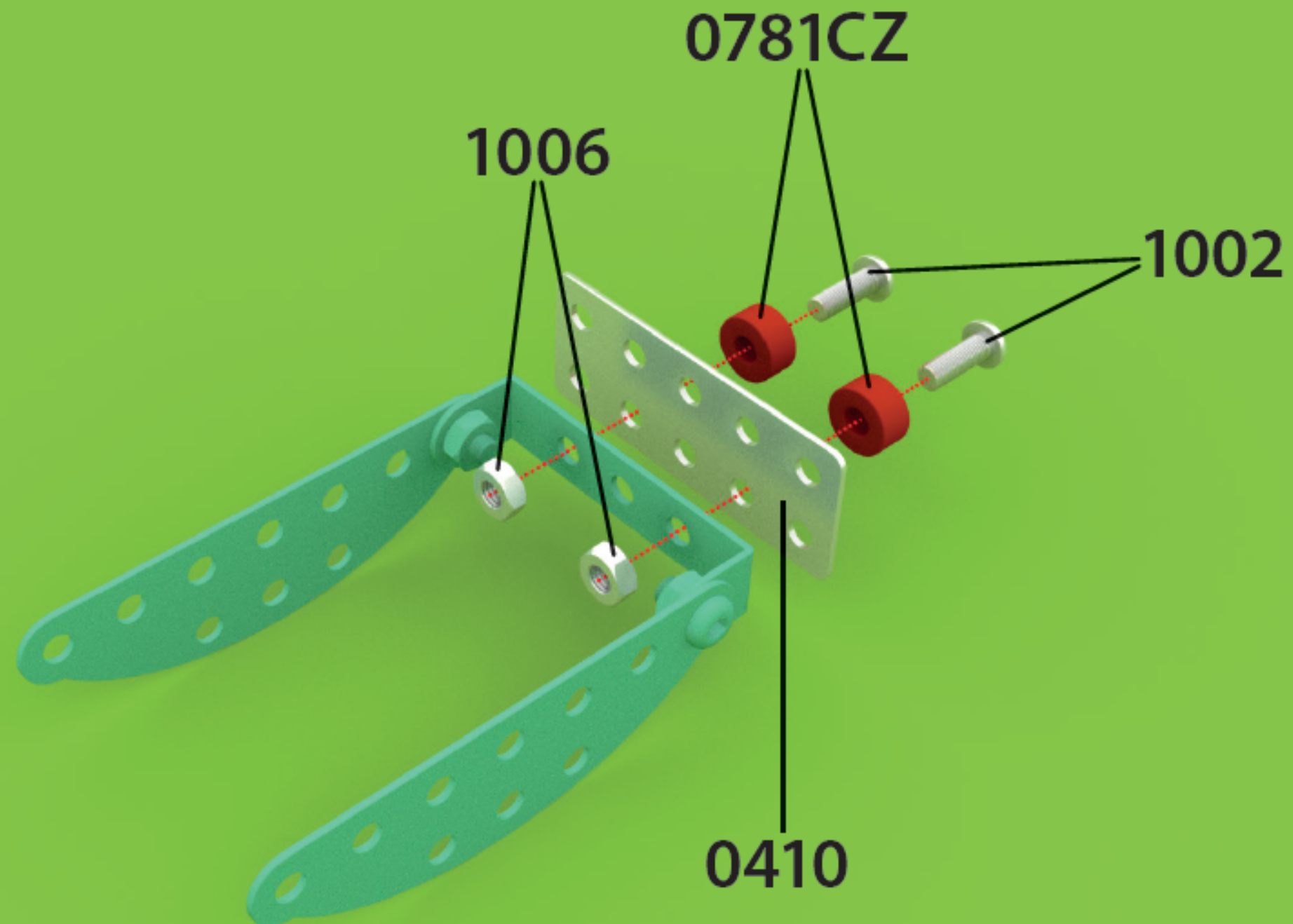

0421

0421

03P5

1001

1006

1001



x 2





x 1





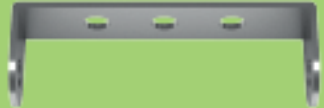

x 2

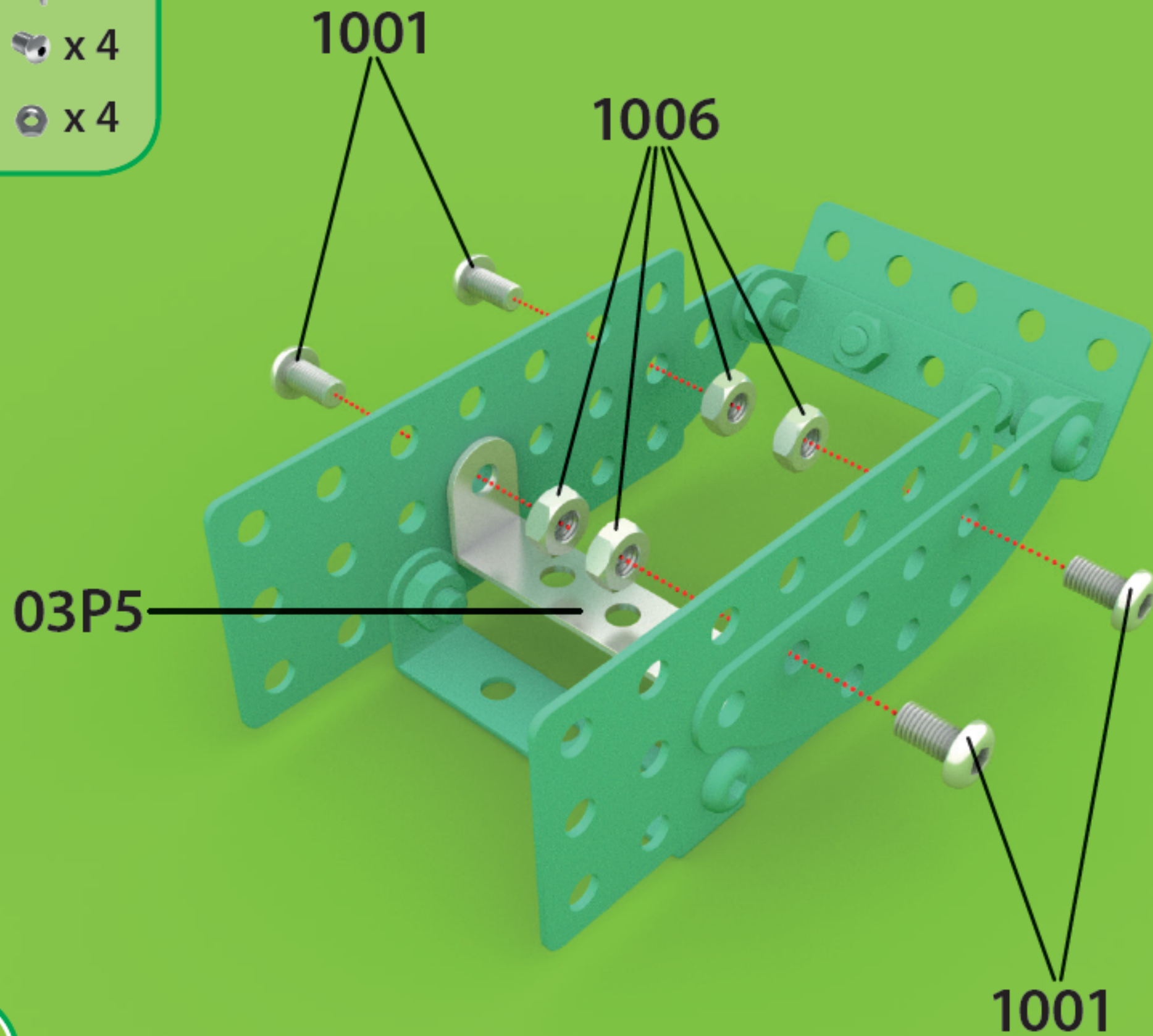

x 2

-  x 1
-  x 4
-  x 4



-  x 1
-  x 2
-  x 2
-  x 2

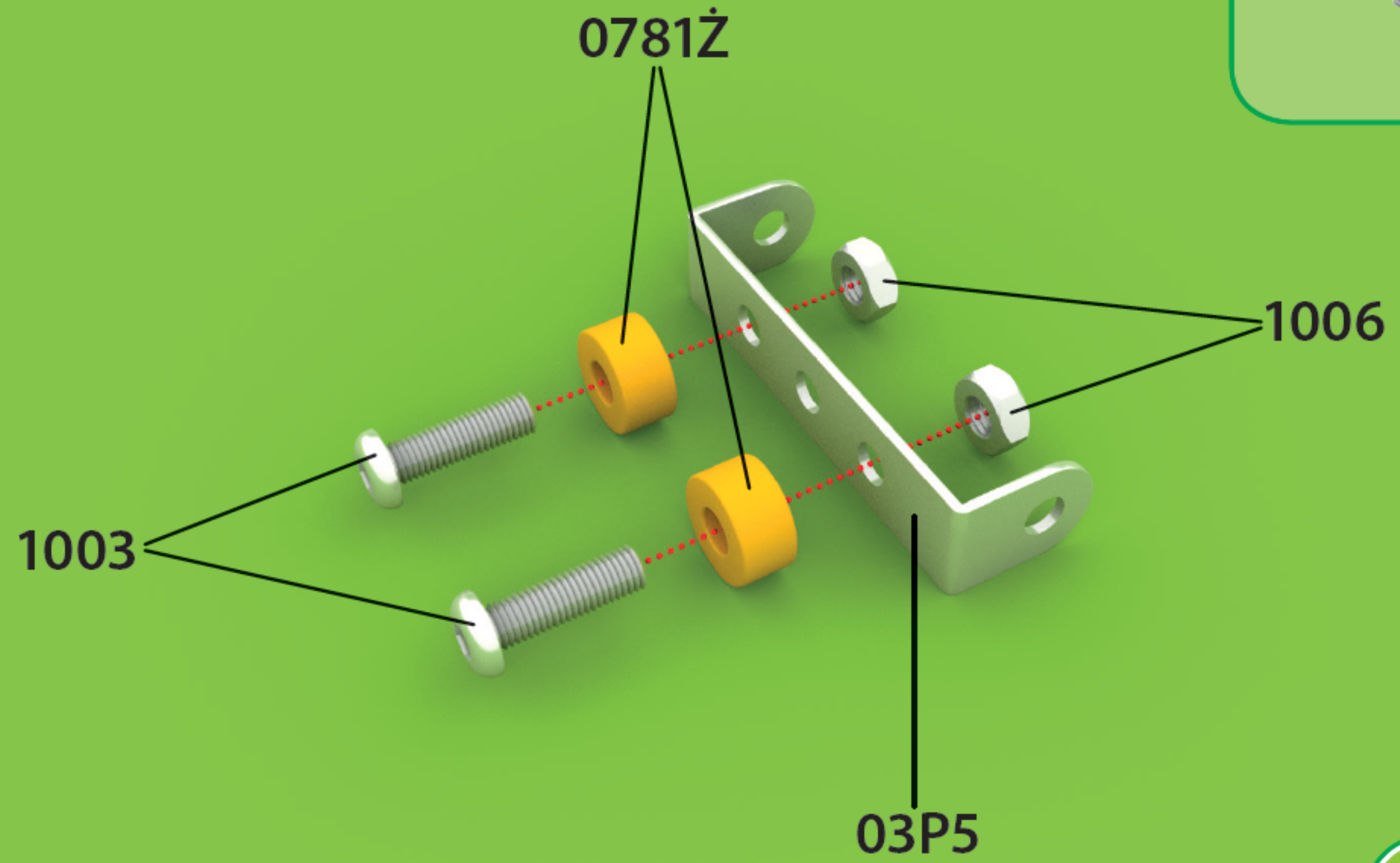



x 2



x 1



x 4



x 4

0613

1001

1006

03P5

0613

1001

 x 2

 x 2

1001



1006



1001





x 2

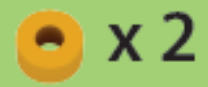

x 2



x 1





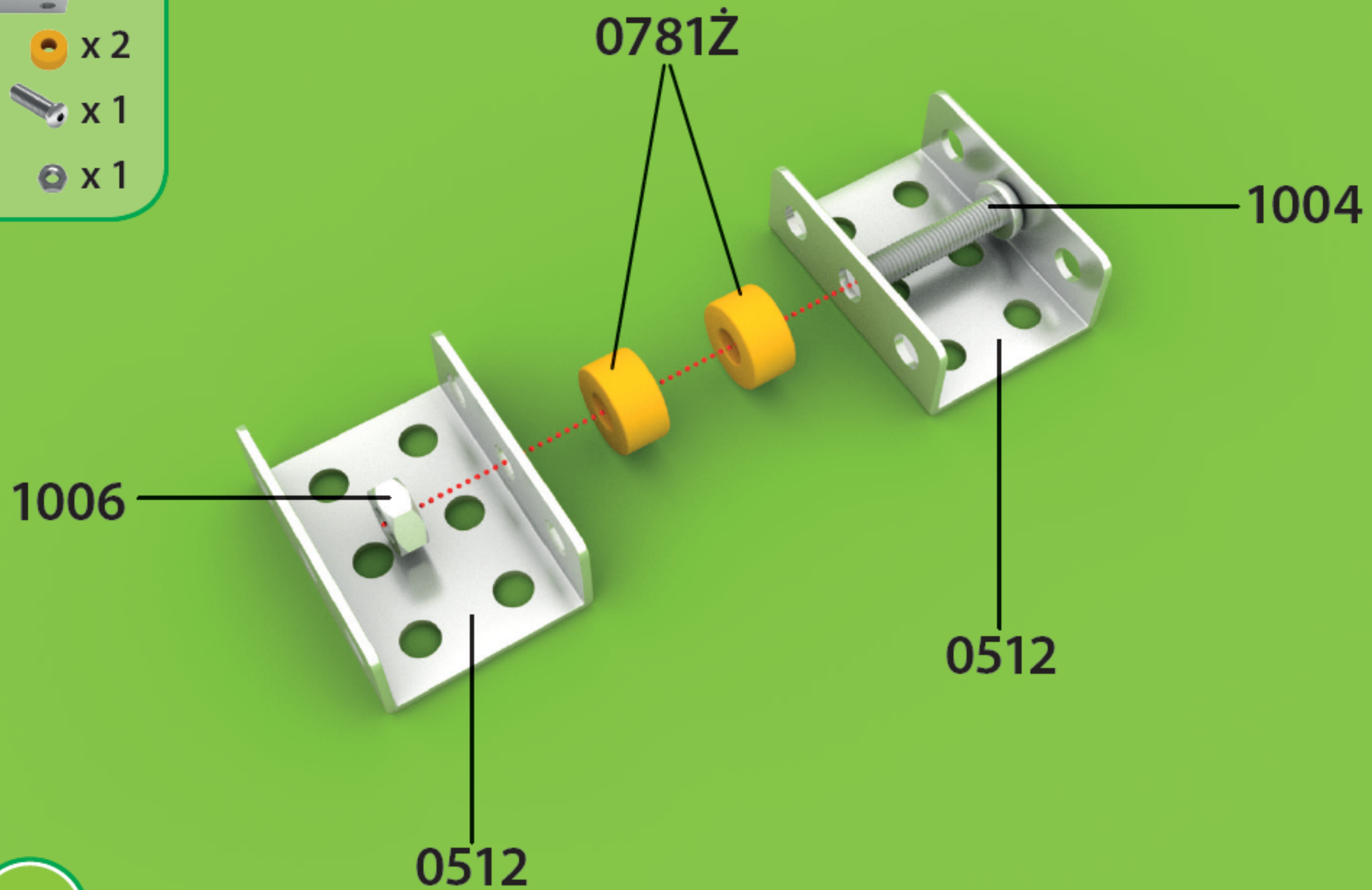

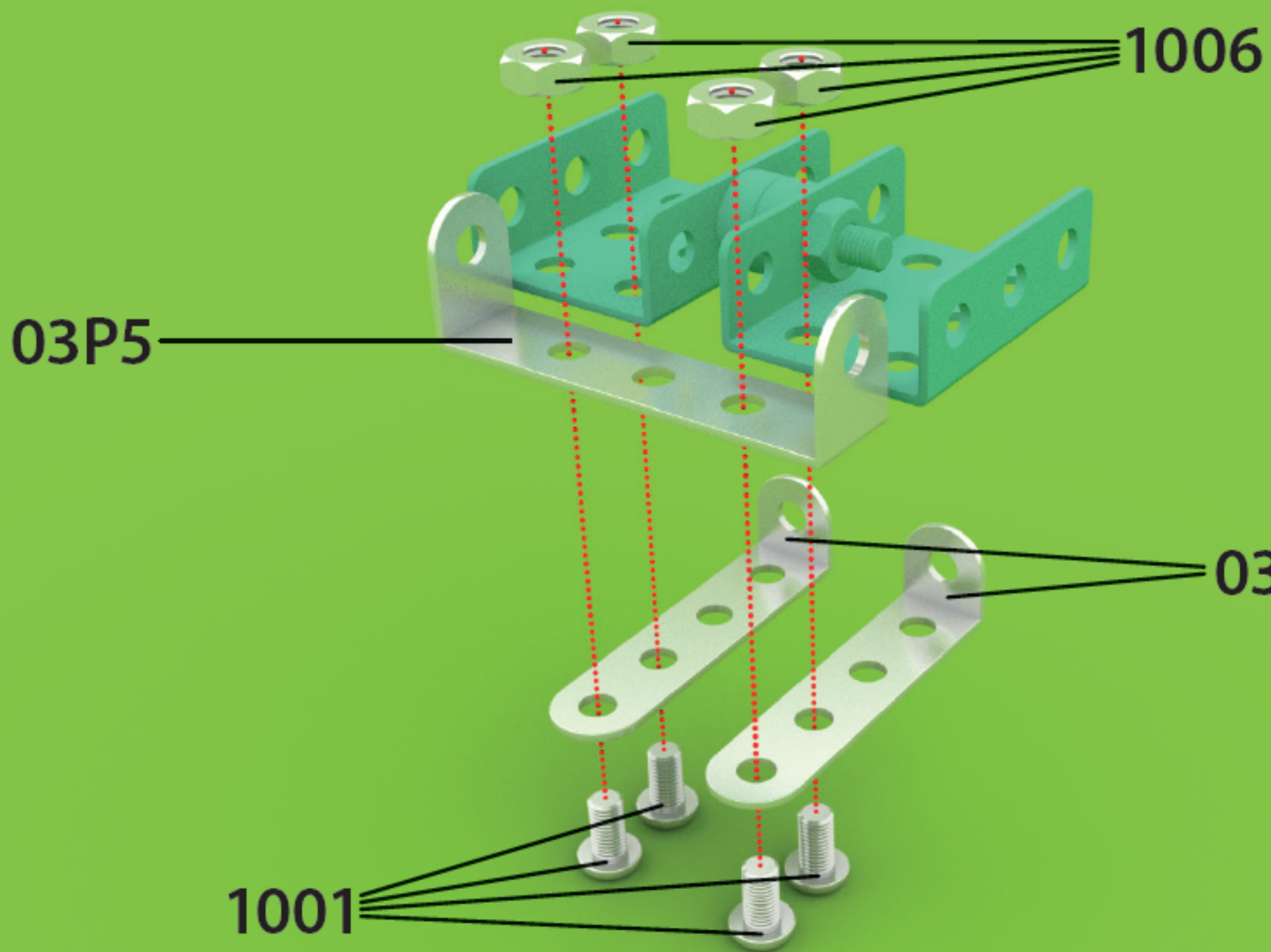

x 1

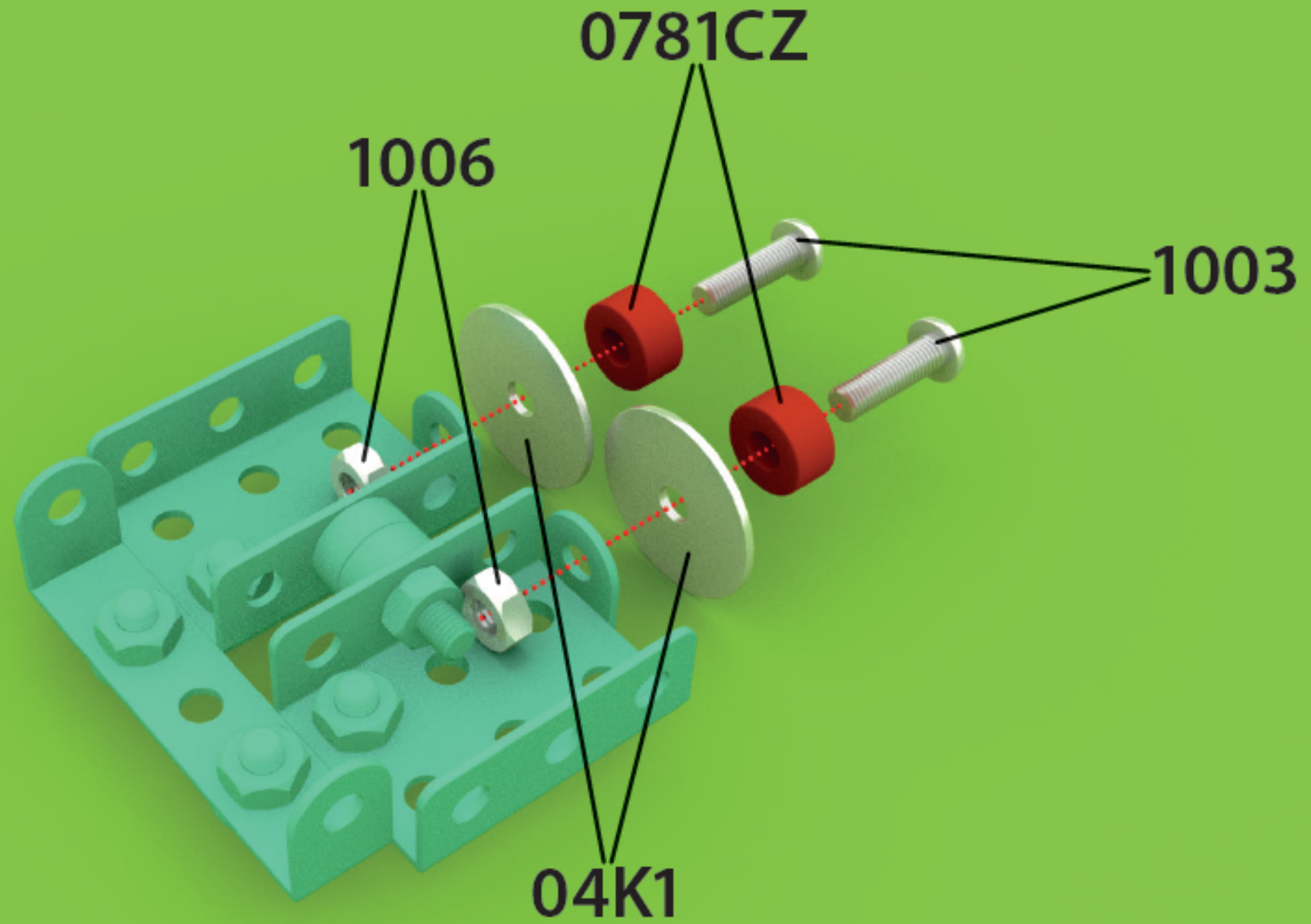
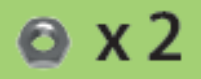
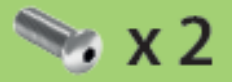
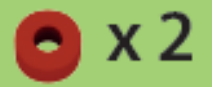







-  x 1
-  x 2
-  x 4
-  x 4

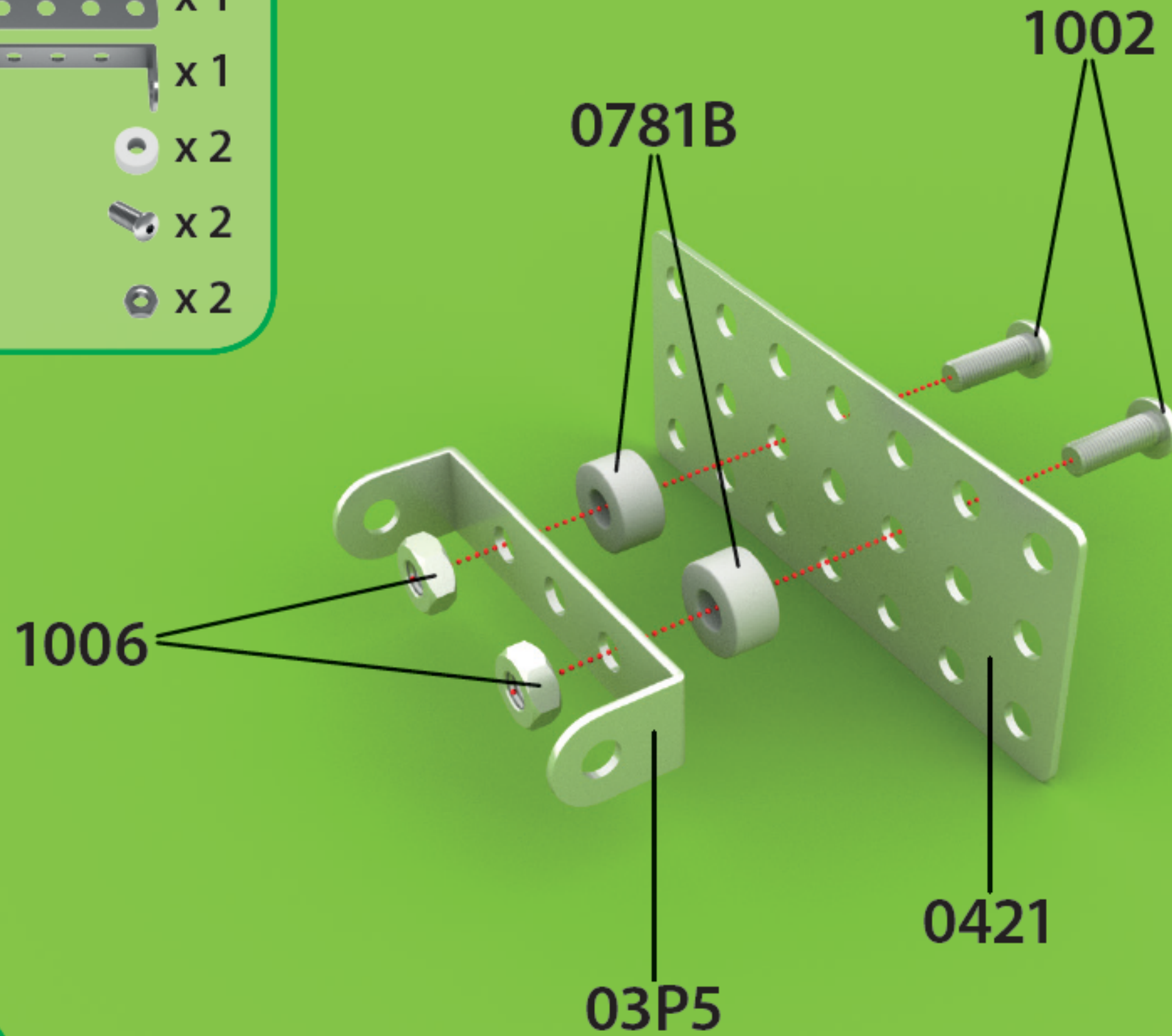

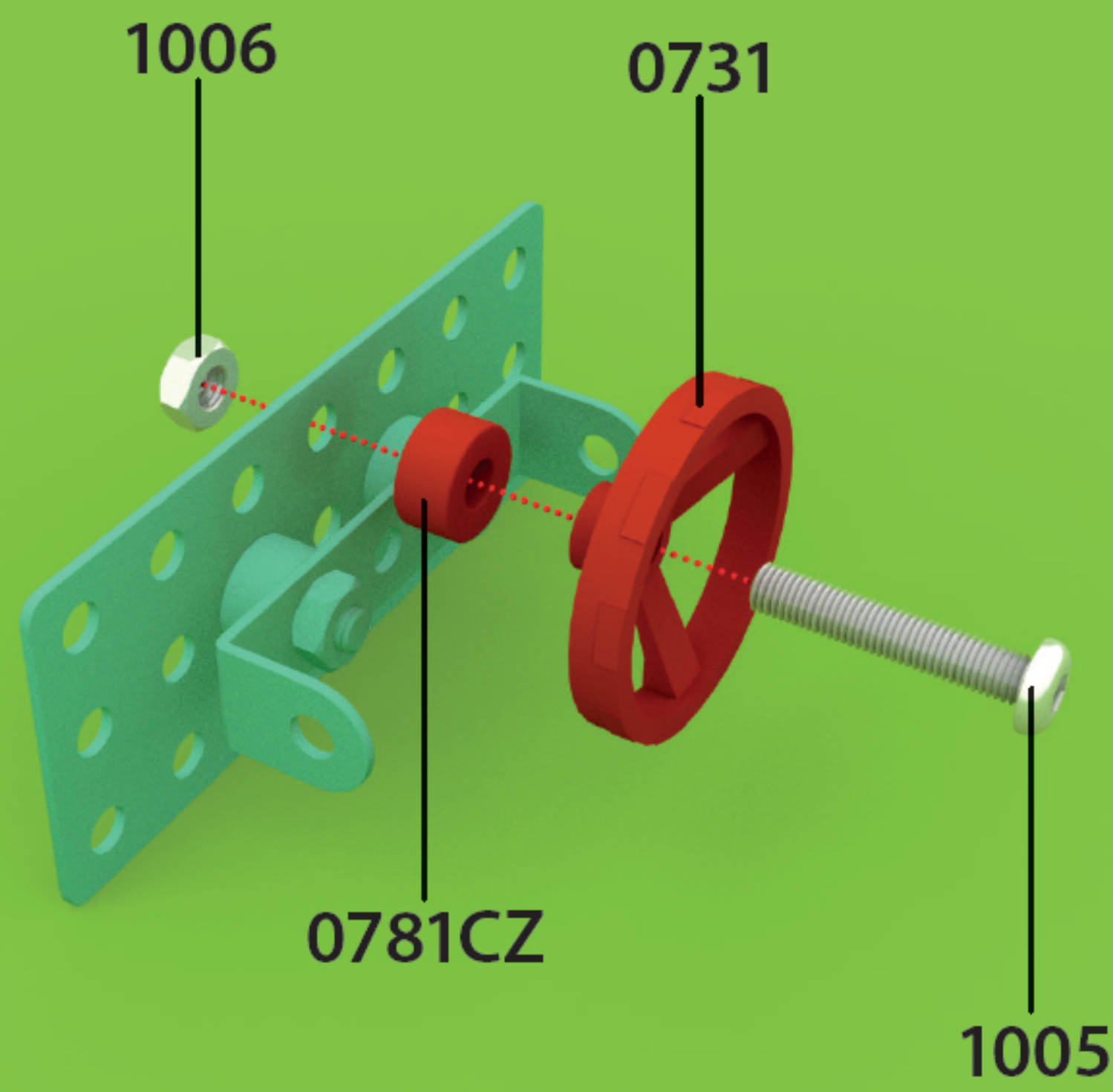

-  x 1
-  x 1
-  x 2
-  x 2
-  x 2







-  x 1
-  x 1
-  x 1
-  x 1

 x 2

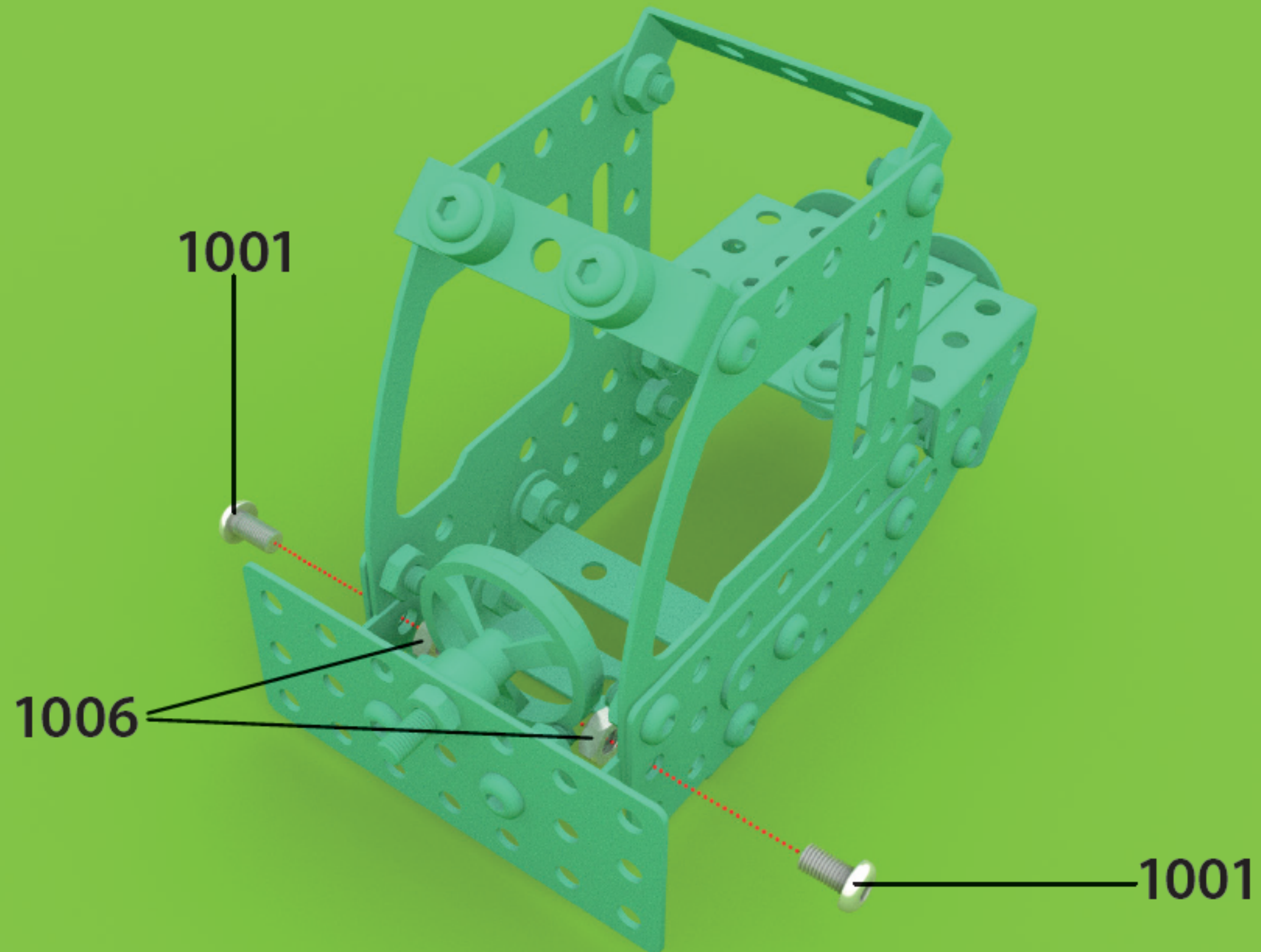
 x 2



 x 4

 x 4

 x 4

1006

0781Ž

1002

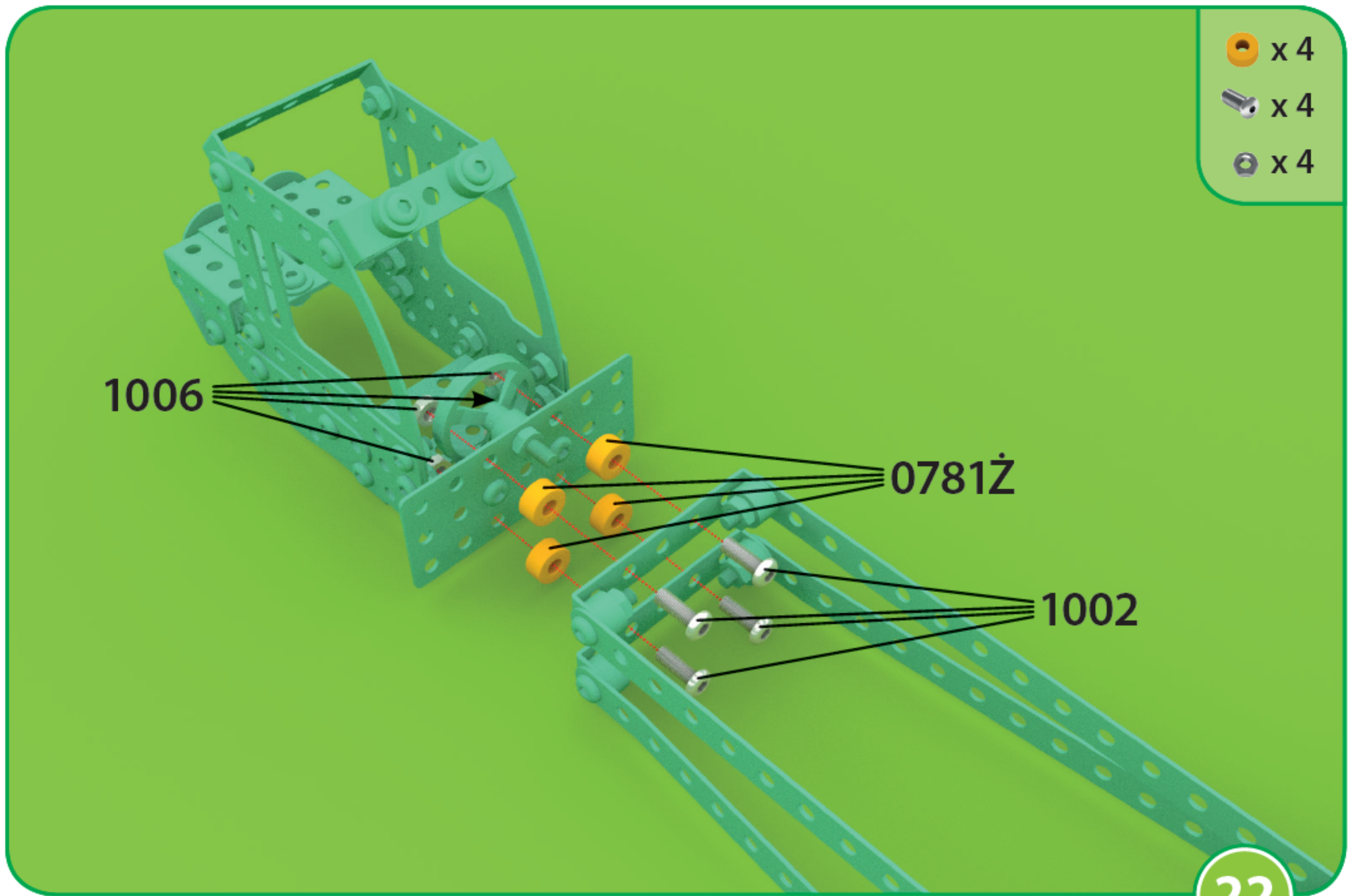



x 1



x 1



x 2



x 2



x 2







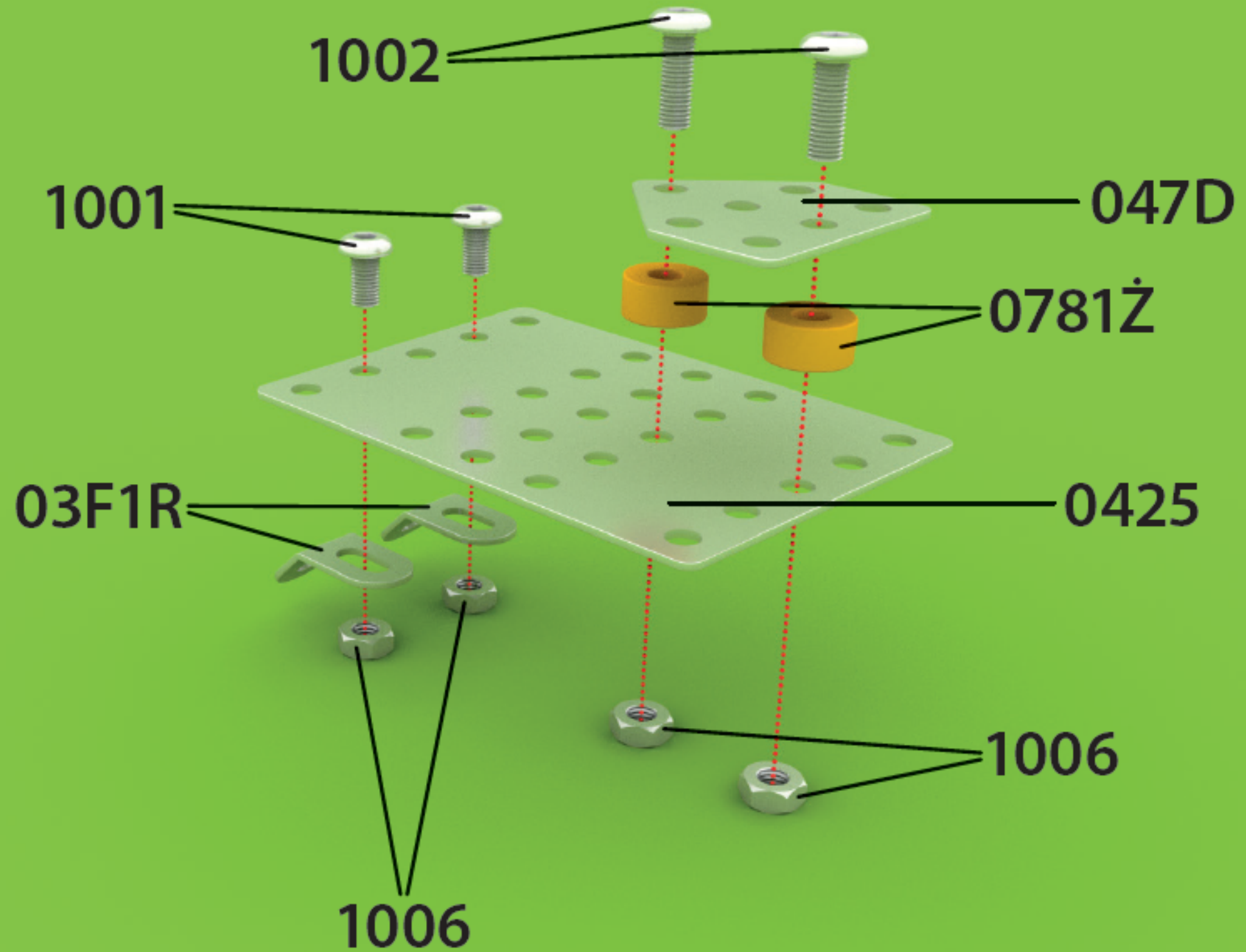

x 2

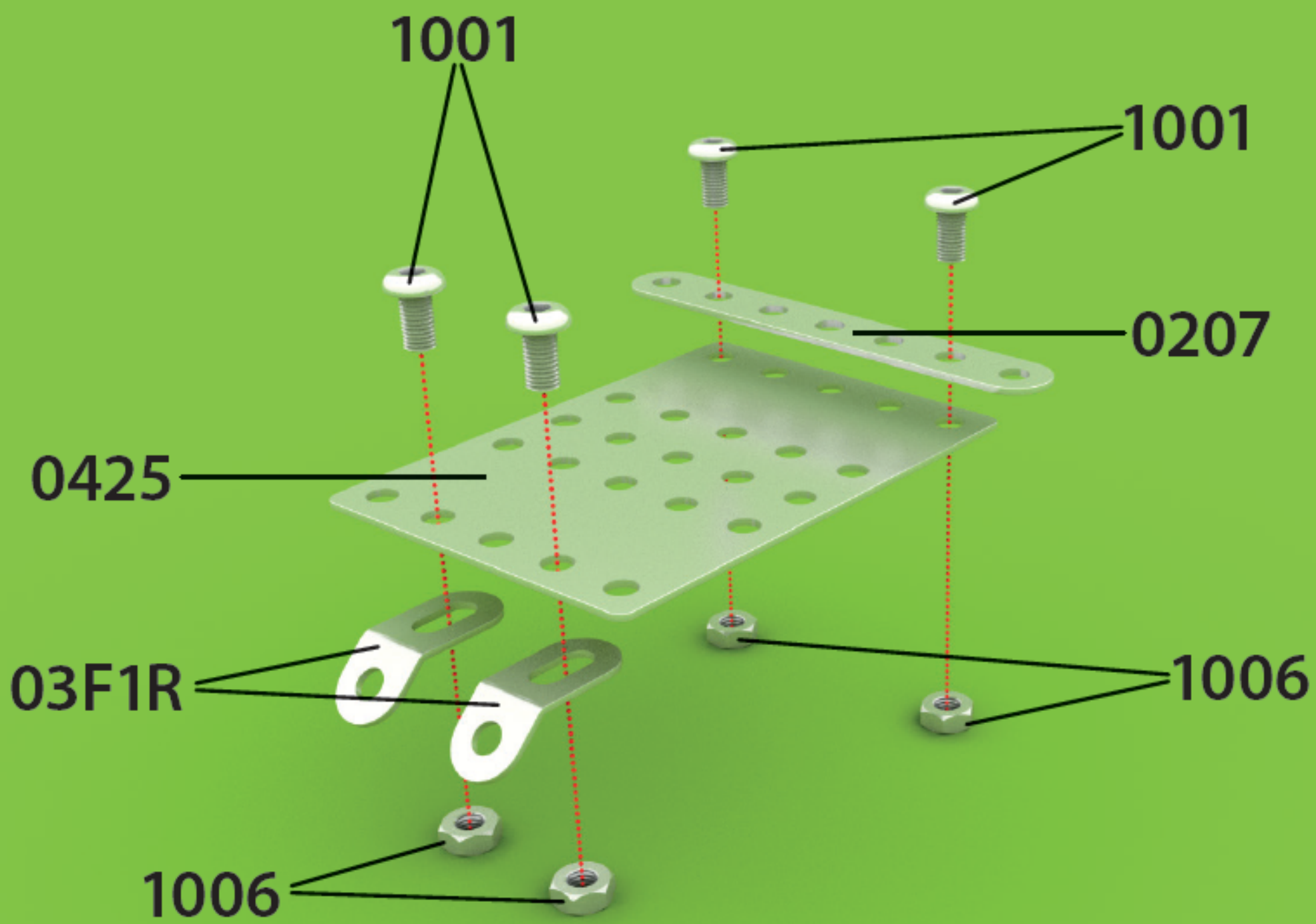

x 4





-  x 1
-  x 1
-  x 2
-  x 4
-  x 4



x 1



x 4



x 4

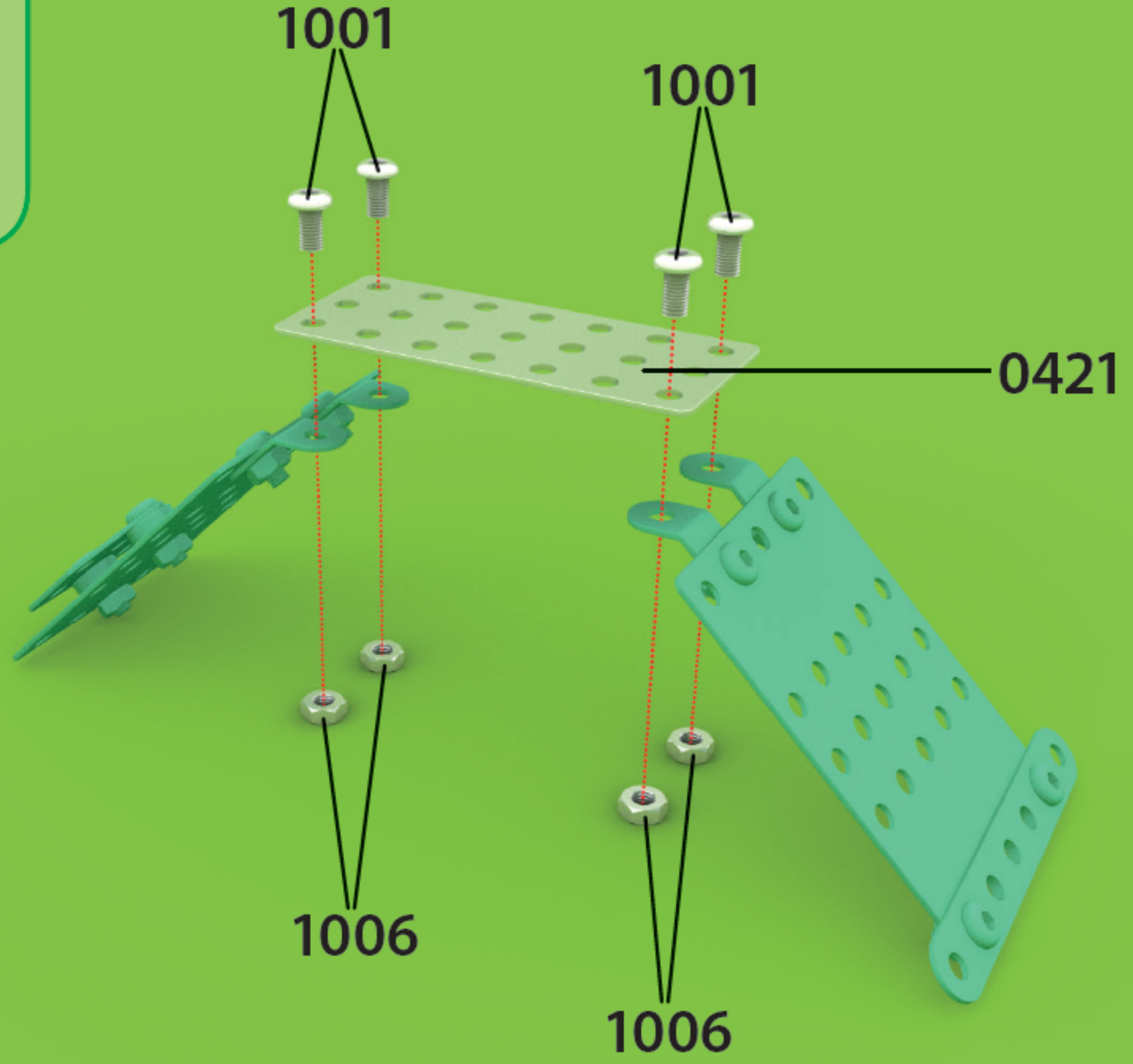

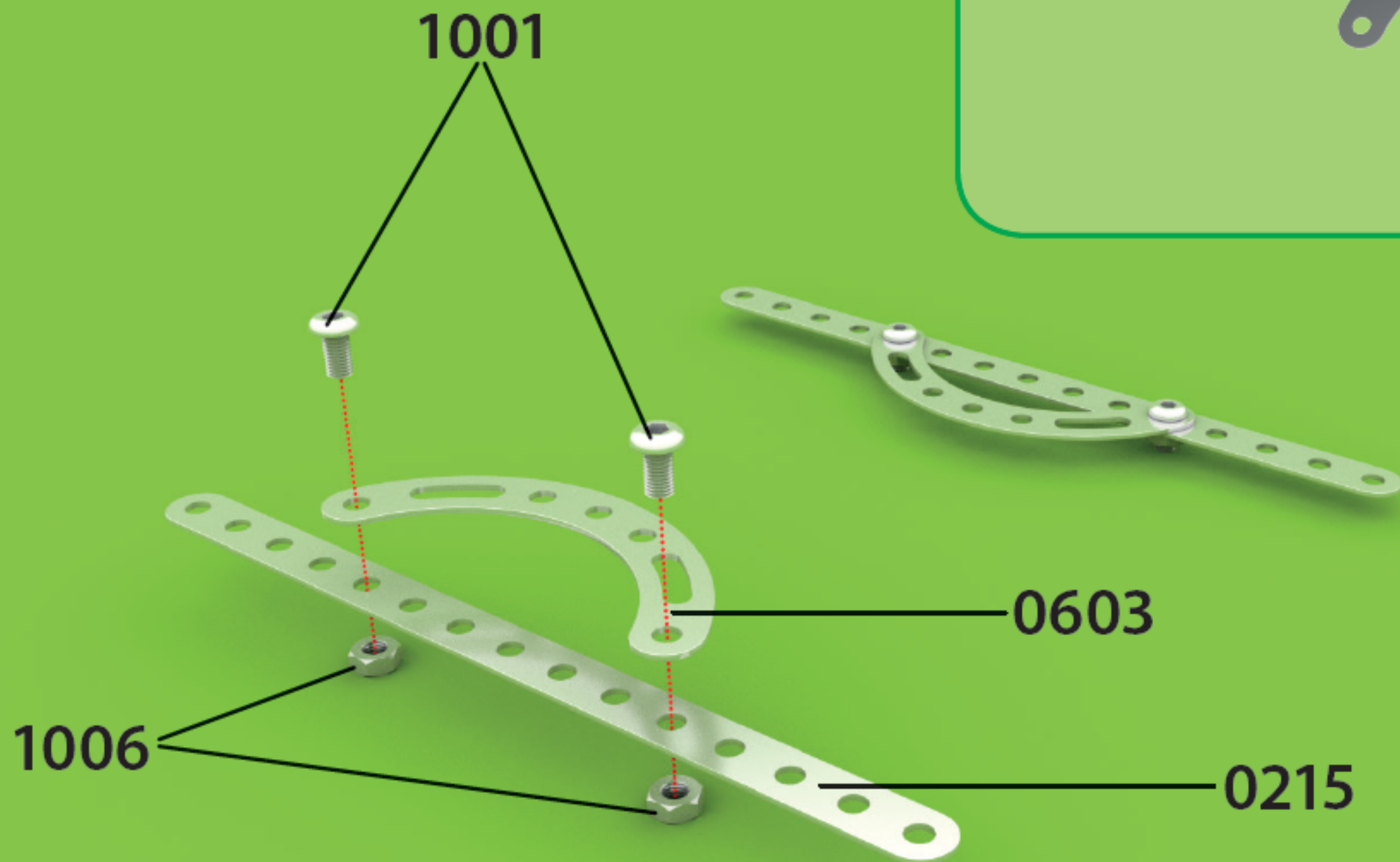

 x 2

 x 2

 x 4

 x 4

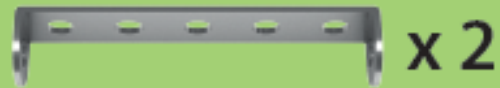

x 2







x 4

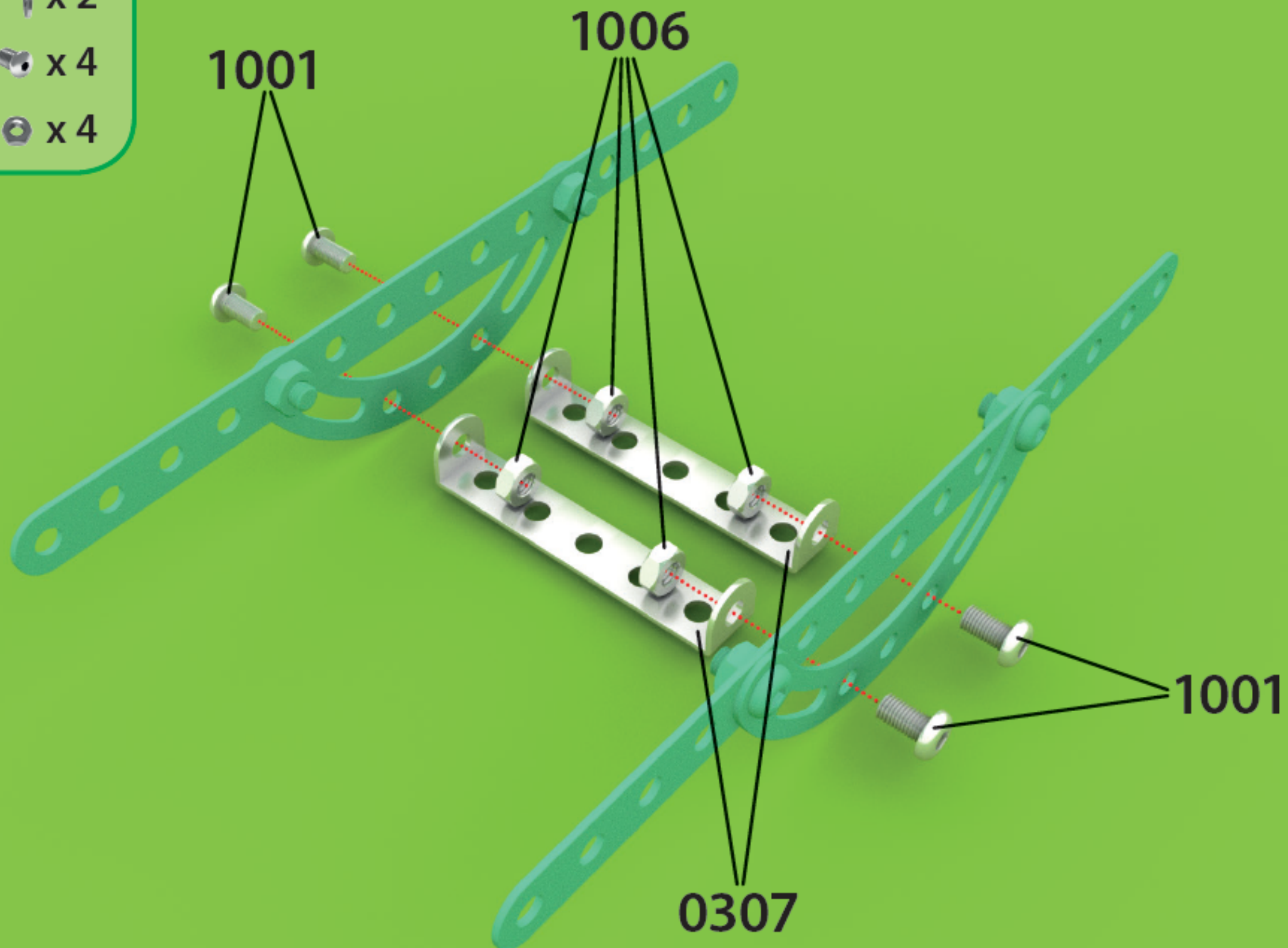

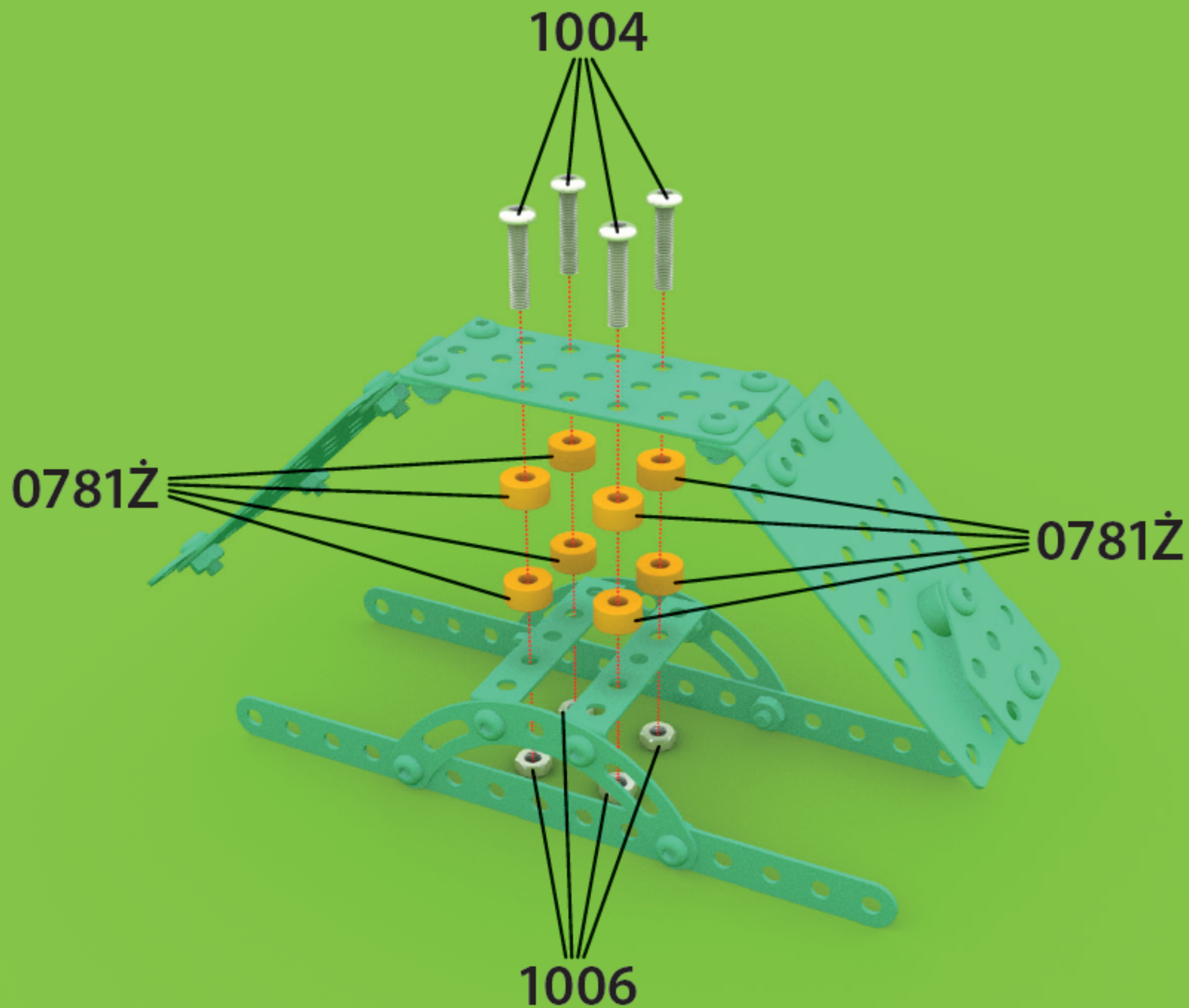
x 4





-  x 8
-  x 4
-  x 4



x 4



x 4



x 4



x 4

03P5R

047DW

1006

1001

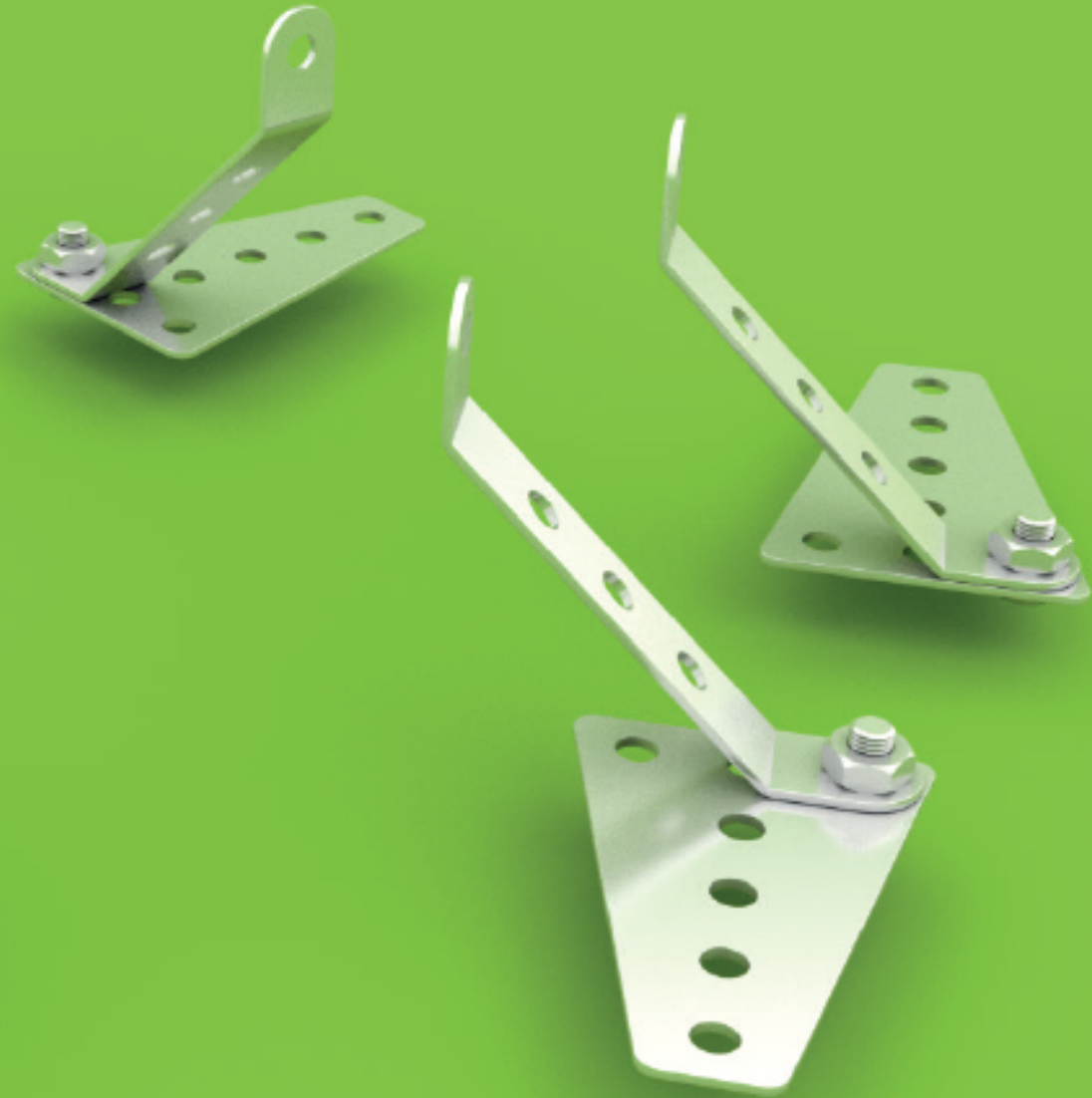

 x 4

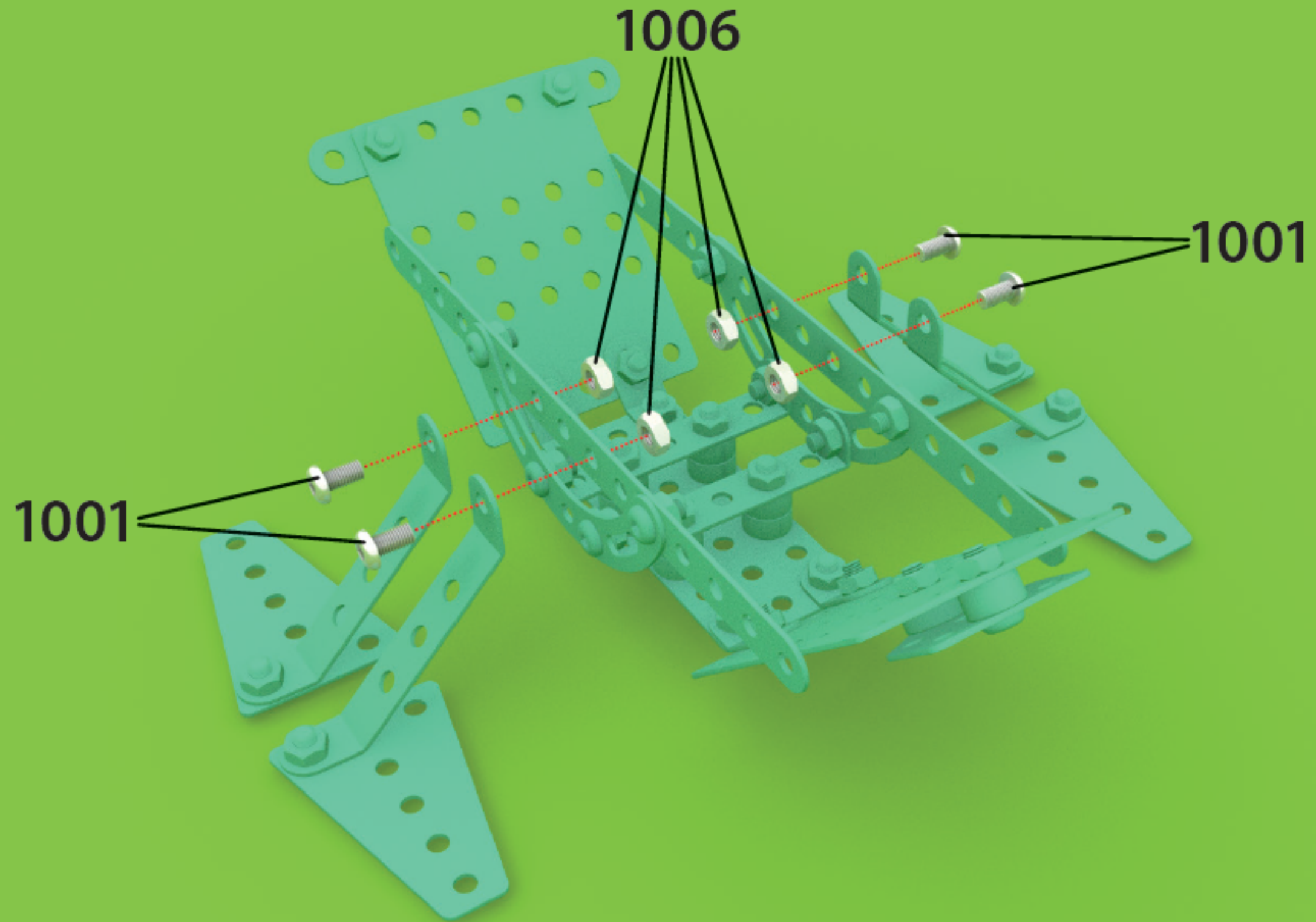

 x 4

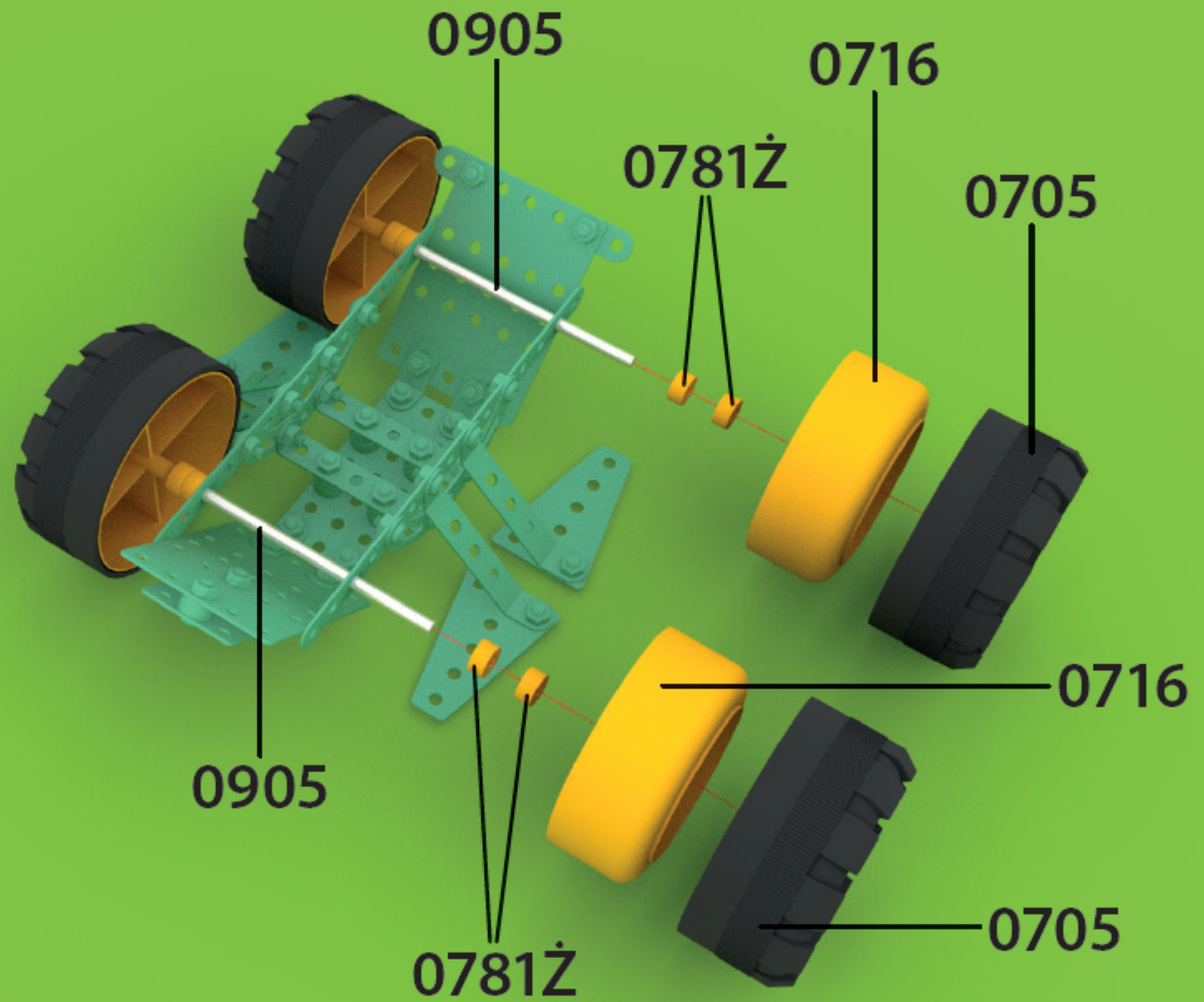

-  x 2
-  x 4
-  x 4
-  x 8

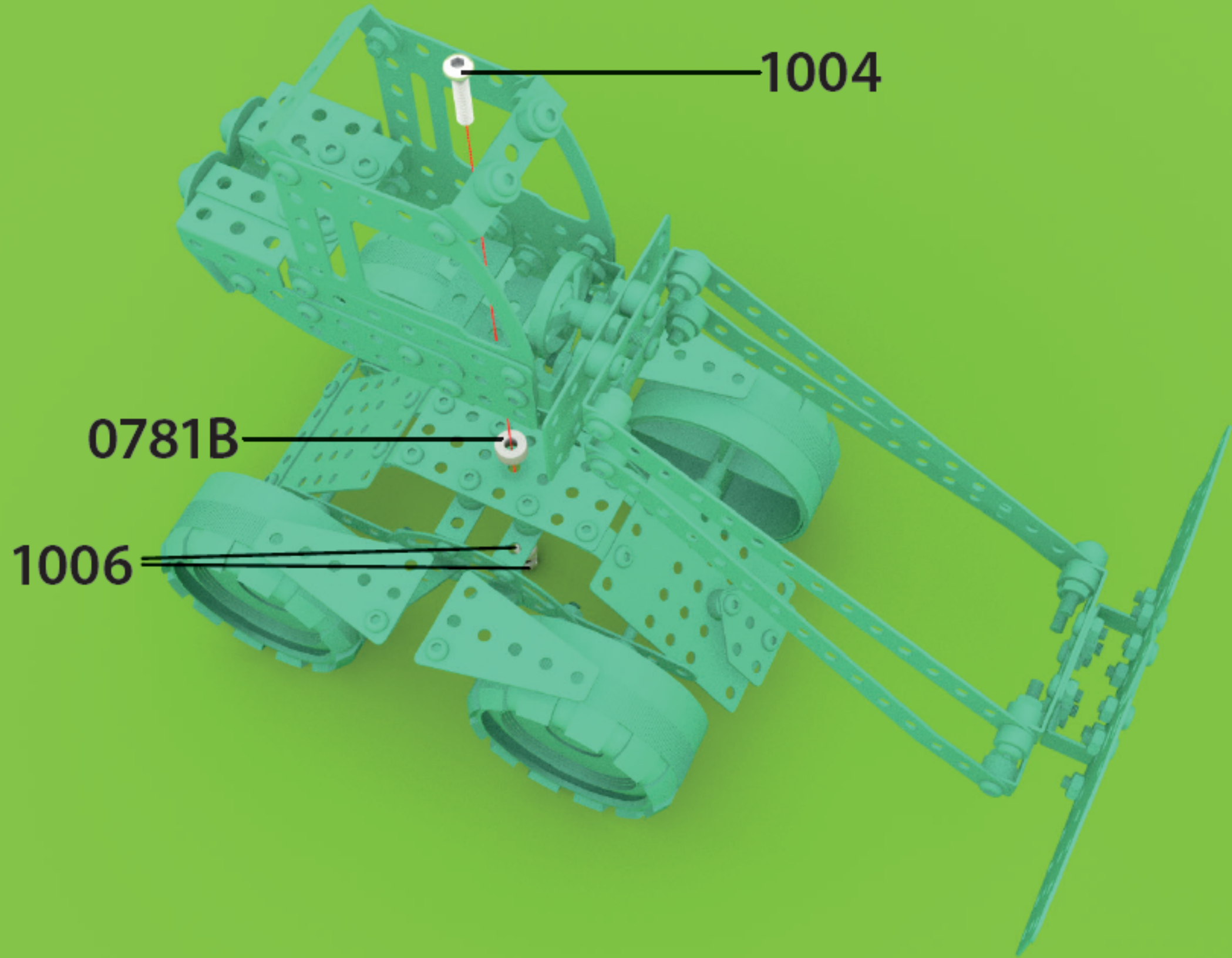



-  x 1
-  x 1
-  x 2



x 2



x 1



x 1



x 1



x 1



x 1

1001

1005

0721

0721

1006

032F

0781Ž

⦿ x 1

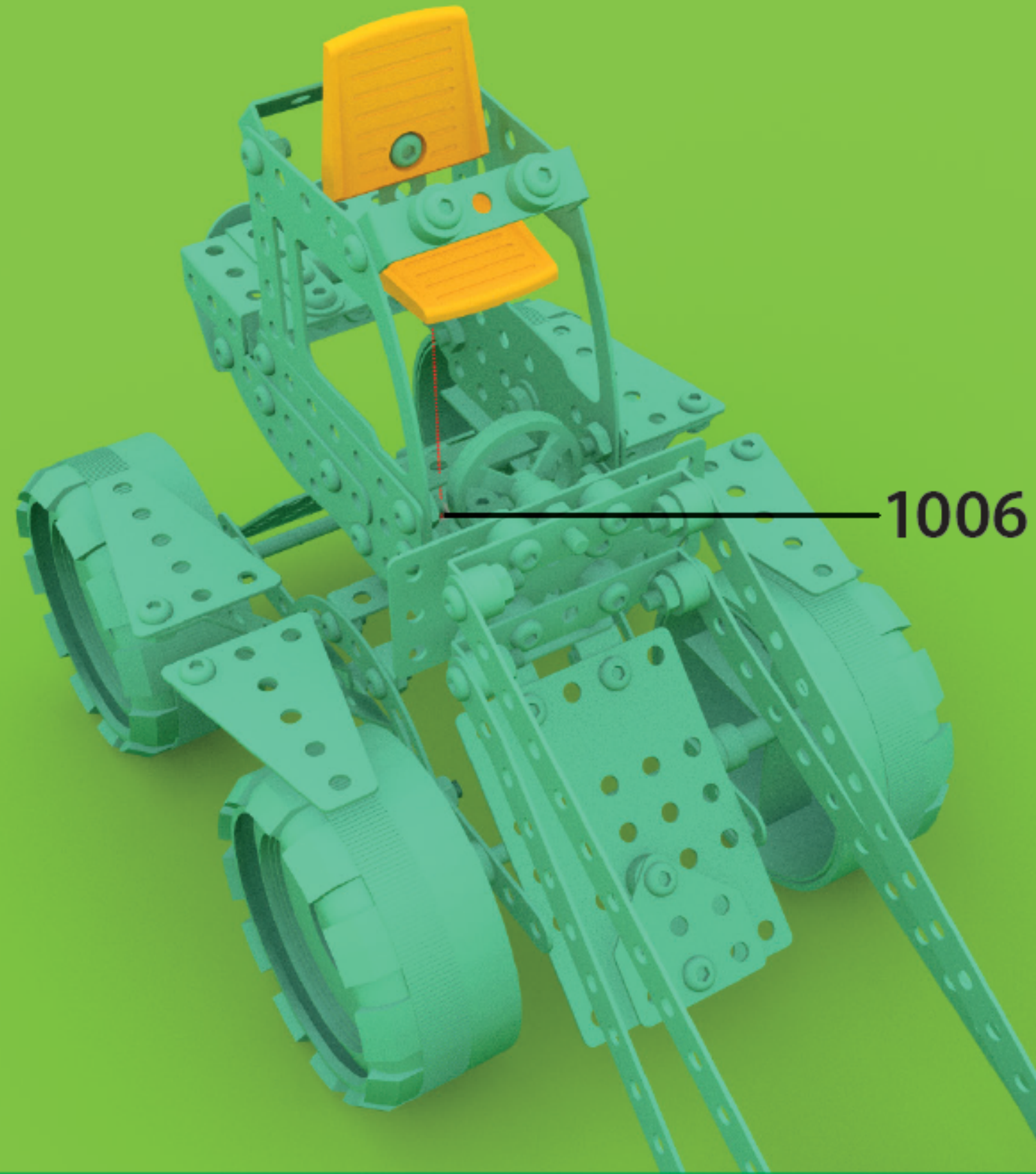

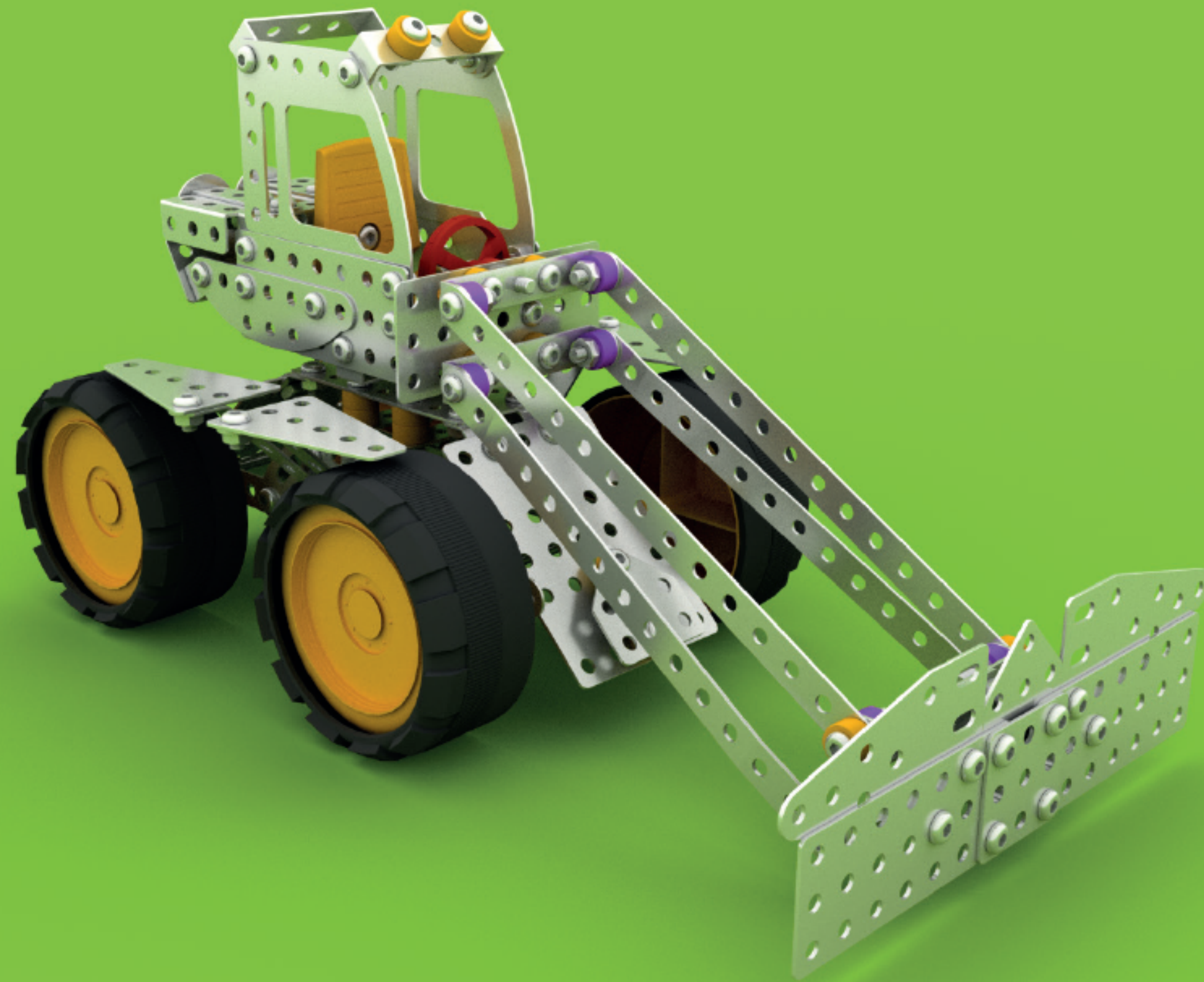

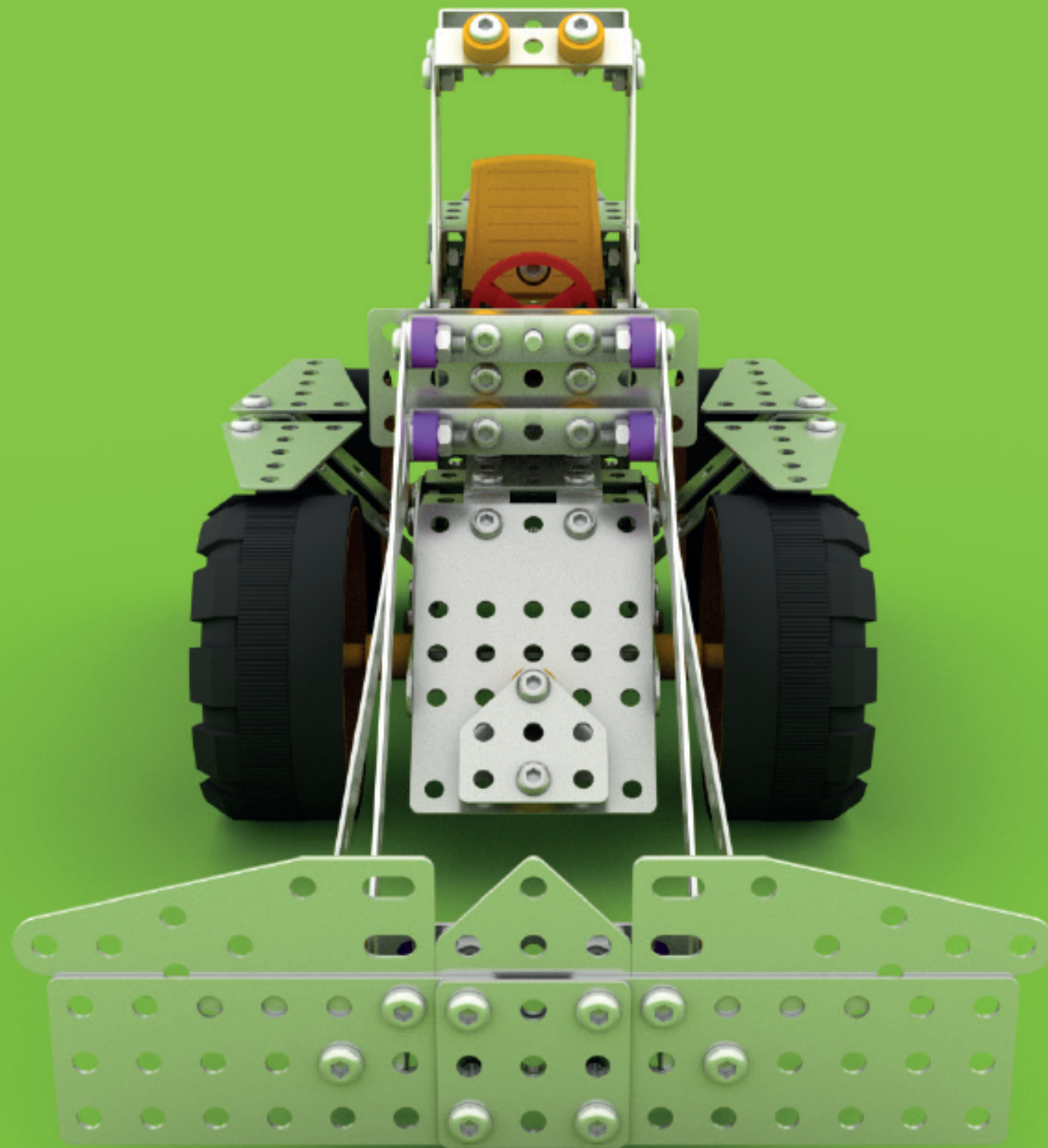



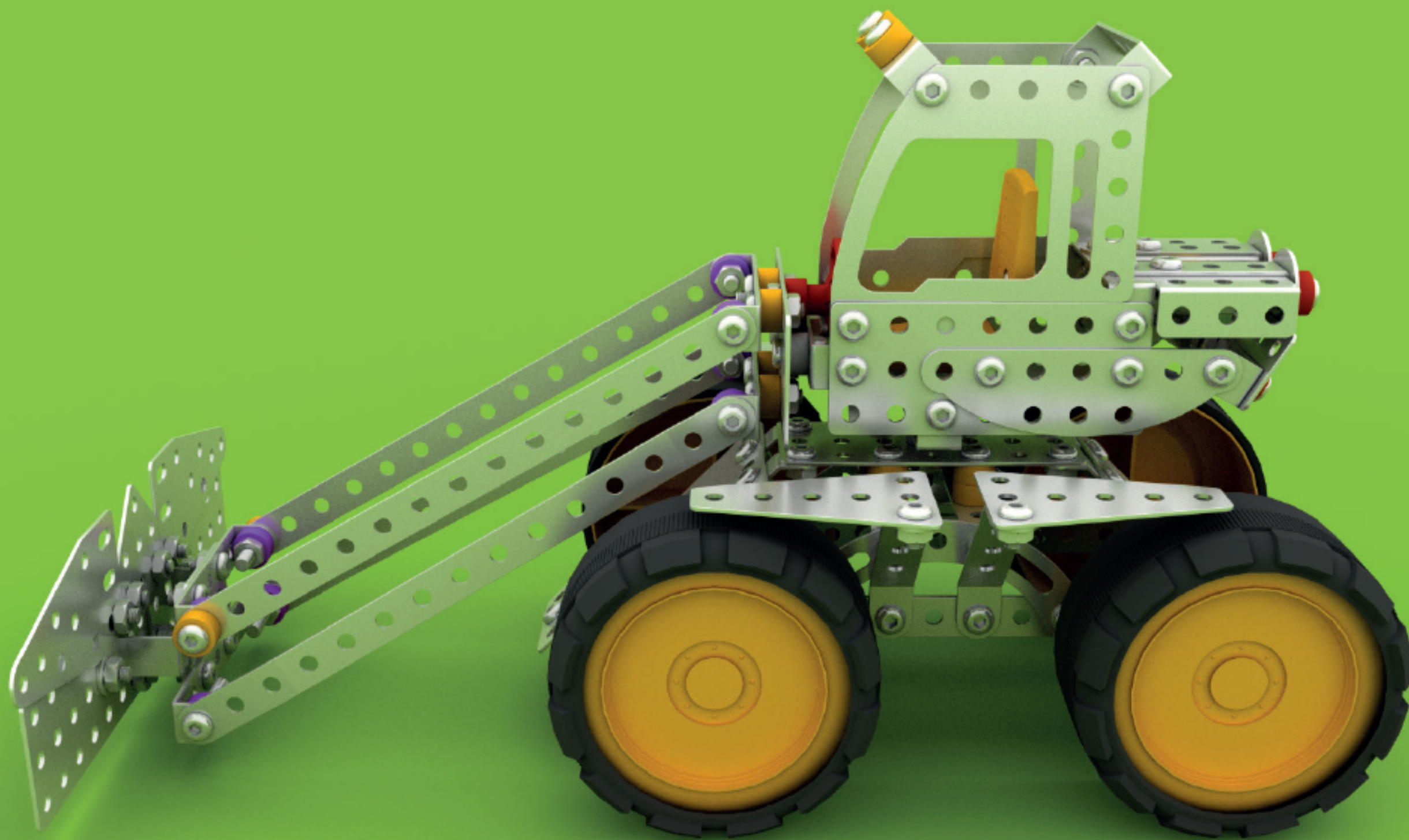

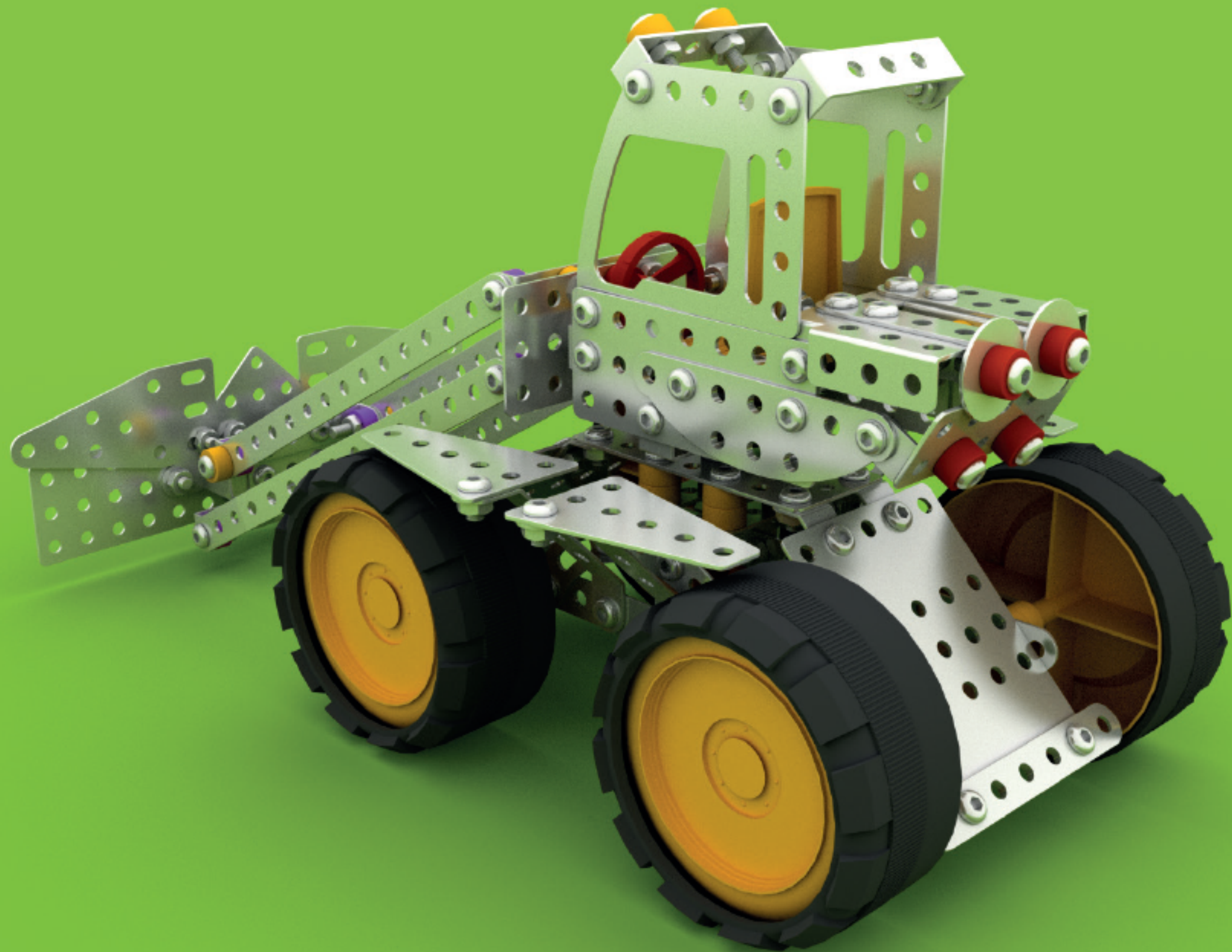

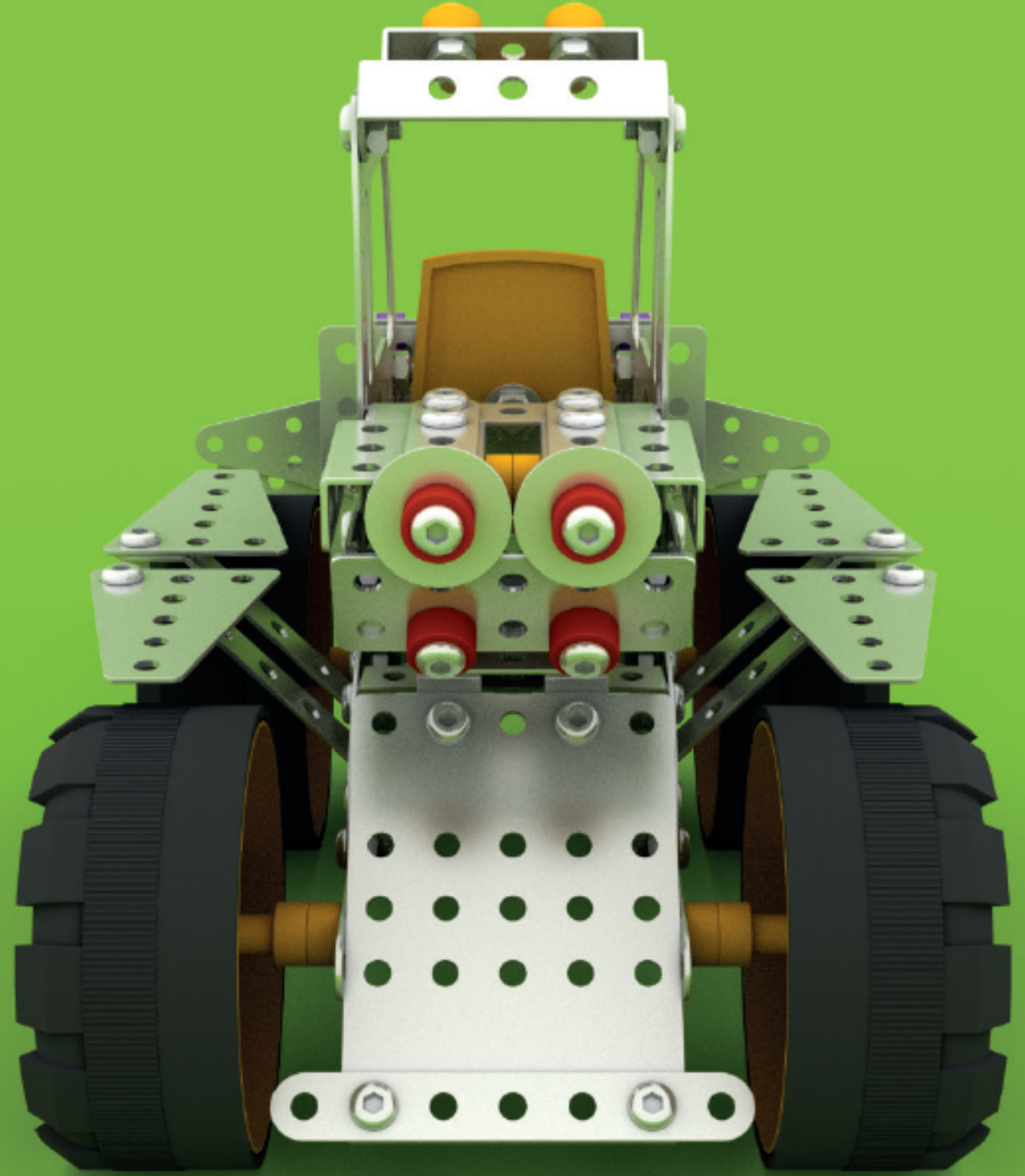

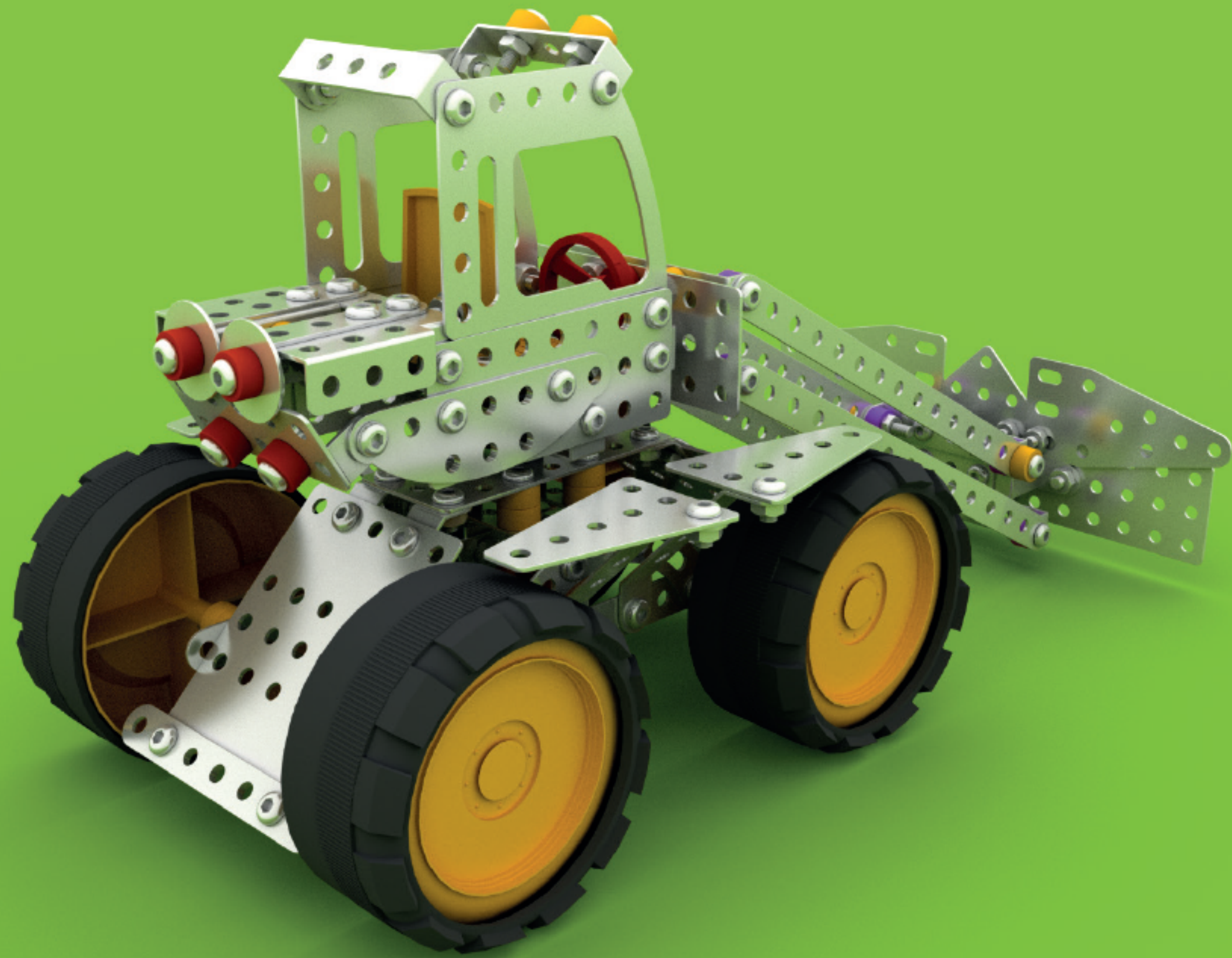

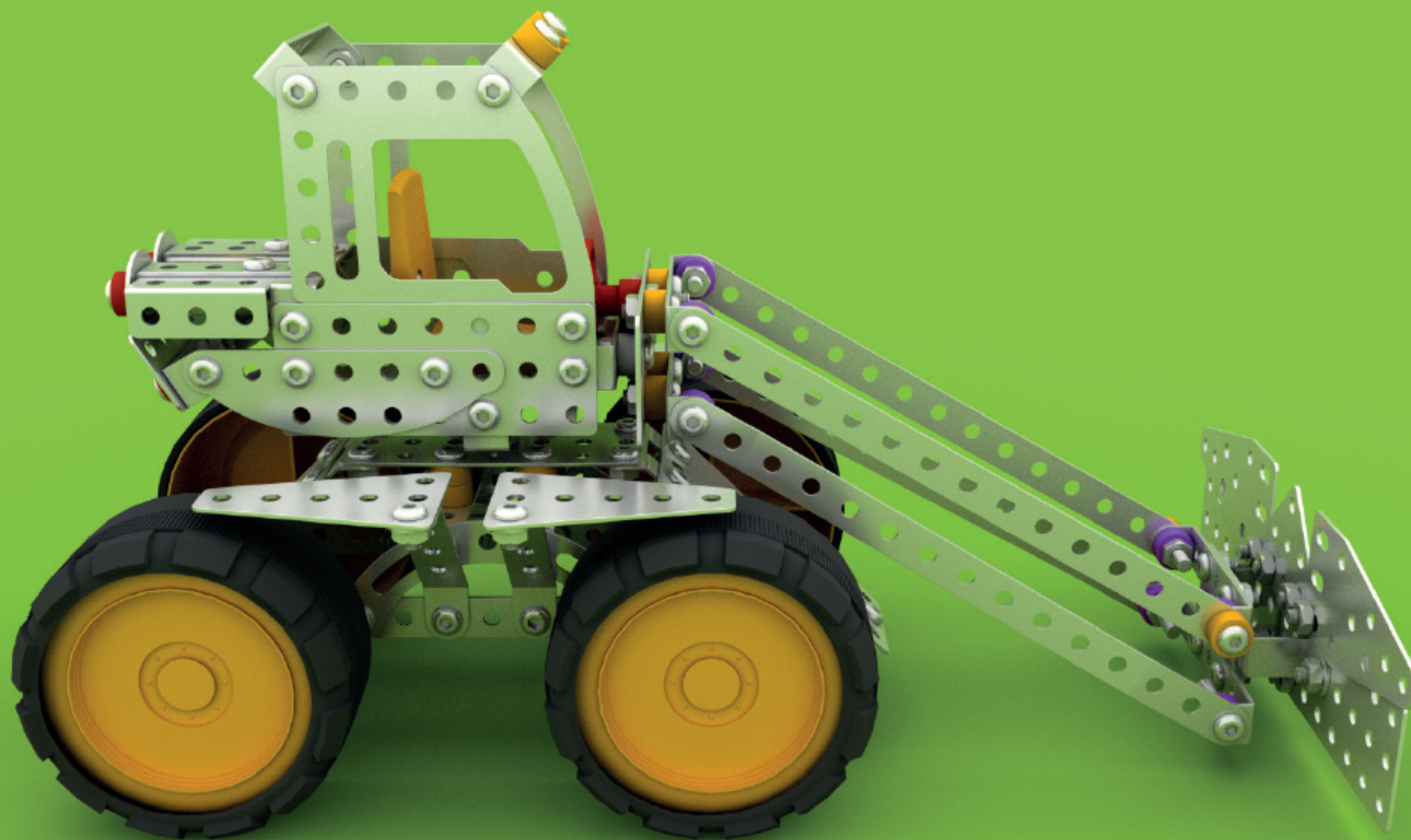

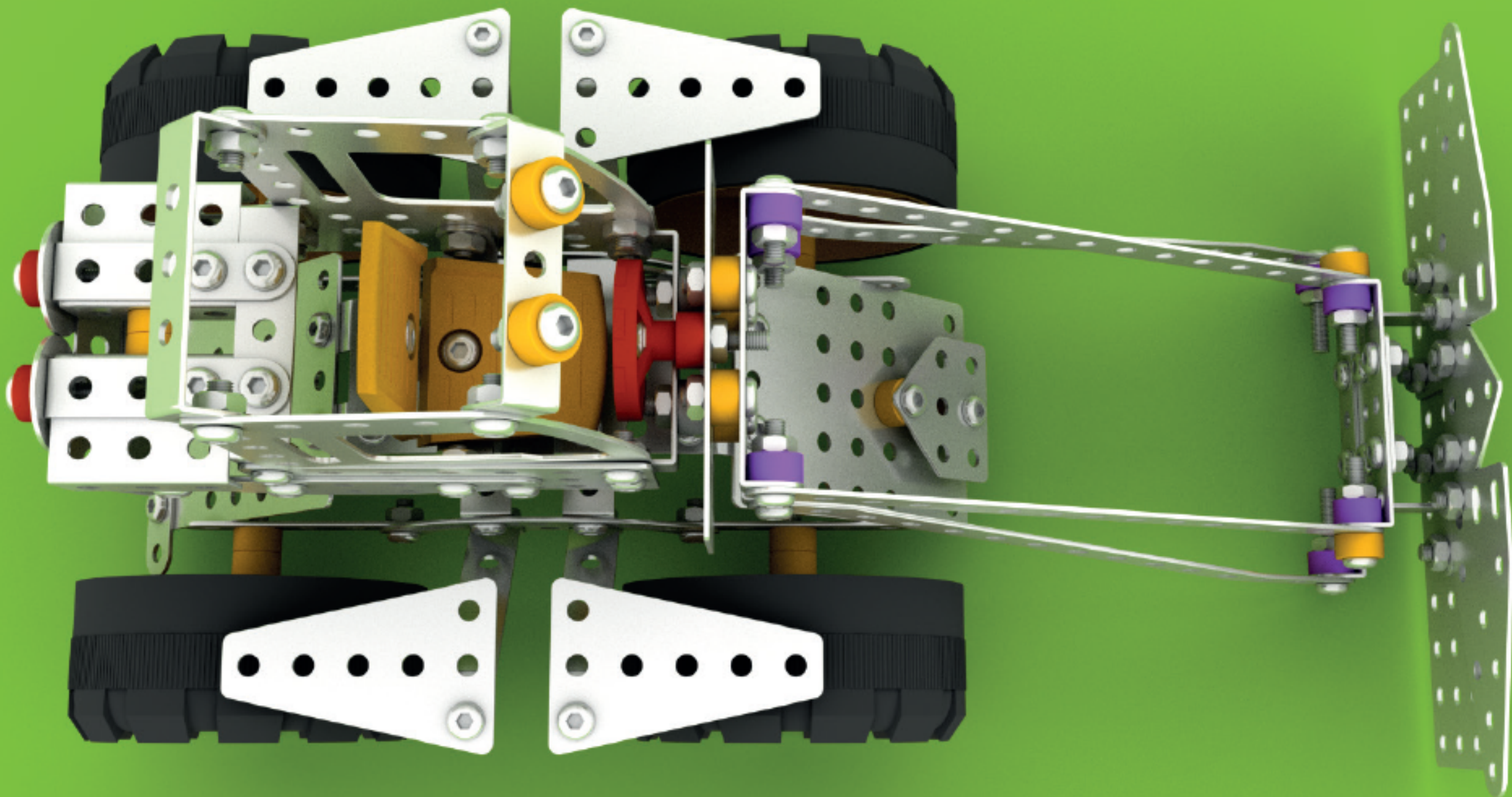

PL: Ostrzeżenia! Nieodpowiednie dla dzieci w wieku poniżej 3 lat. Zestaw zawiera małe elementy – niebezpieczeństwo zakrztuszenia. Prosimy zachować opakowanie ze względu na podane informacje. **EN:** Warnings! Unsuitable for children under the age of 3. Contains small parts – choking hazard. Keep the box for future reference. **DE:** Achtung! Nicht für Kinder unter 3 Jahren geeignet. Enthält kleine Teile, die verschluckt werden können – Erstickungsgefahr. Verpackung für spätere Rückfragen aufbewahren. **FR:** Attention! Ne convient pas aux enfants de moins de 3 ans. Contient des petits éléments pouvant être avalés et engendrer un risque d'étouffement. Documentation à lire et à conserver pour consultation ultérieure. **ES:** ¡Advertencia! No recomendable para niños de 3 años o menores. Peligro de asfixia – piezas pequeñas. Conserve la caja para futuras referencias. **NL:** Waarschuwing! Niet geschikt voor kinderen jonger dan drie jaar. Bevat kleine onderdelen – verstikkingsgevaar opleveren. Bewaar de verpakking, er staat belangrijke informatie op. **CZ:** Upozornění! Nevhodné pro děti do 3 let. Balení obsahuje malé dílky – nebezpečí udušení. Zachovejte prosím obal ze vzhledu na uvedené informace. **SK:** Upozornenia! Nevhodné pre deti vo veku do 3 rokov. Súprava obsahuje malé casti – hrozí nebezpečenstvo udusenía. Obal uschovajte vzhľadom na dôležité informácie, ktoré sa na nom nachádzajú.



2593



www.alexander.com.pl