

·MAŁY·KONSTRUKTOR·
·CONSTRUCTOR·
JUNIOR

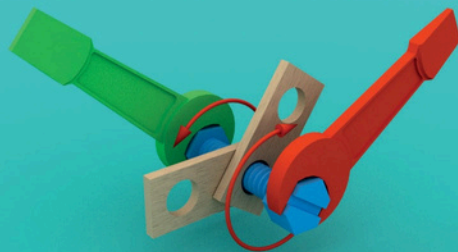

SPOSÓB UŻYCIA NARZĘDZI

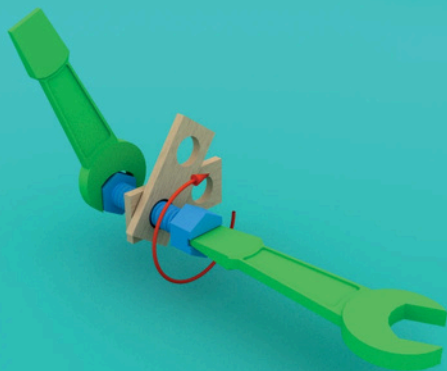



klucz x 2



D02 x 5



D04 x 1



D05 x 2



D06 x 3



D07 x 2



WD12H160 X 2



NP001 x 14



13mm

SP001 x 14



24mm

SP004 x 6

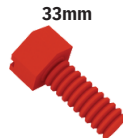

33mm

SP002 x 2

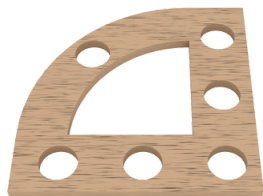

DL01 X 2



0705 X 4







0716 X 4



KP001 x 11



KP001 x 2

-  x 2
-  x 2
-  x 2
-  x 2
-  x 4

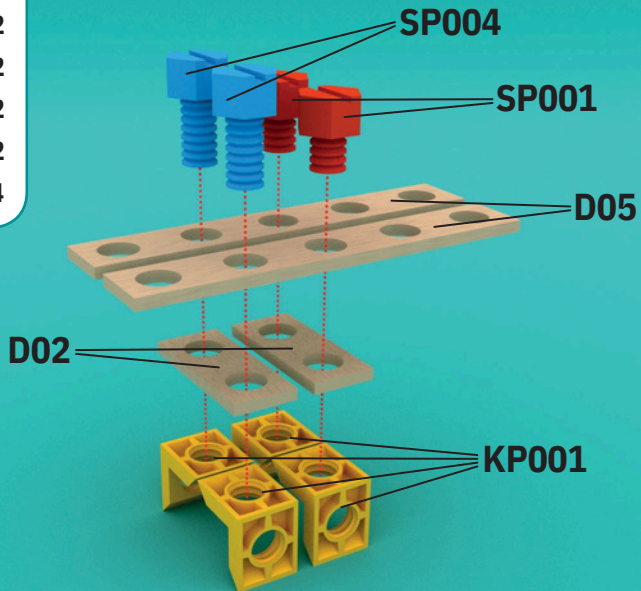

1

 x 2
 x 2

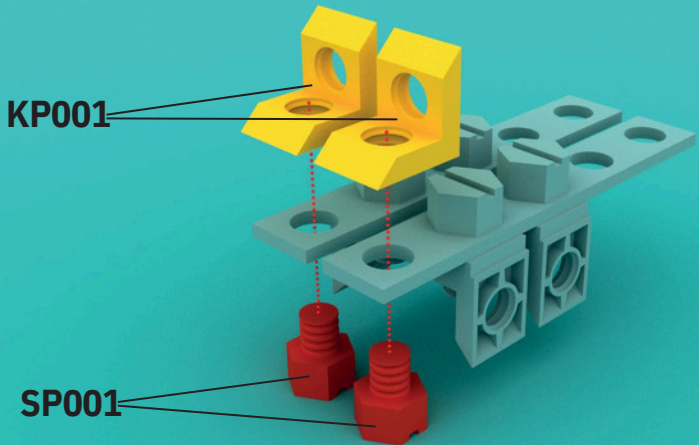

x 1

x 2

x 2

x 2

x 2

SP001

SP004

KP001



NP001

D04

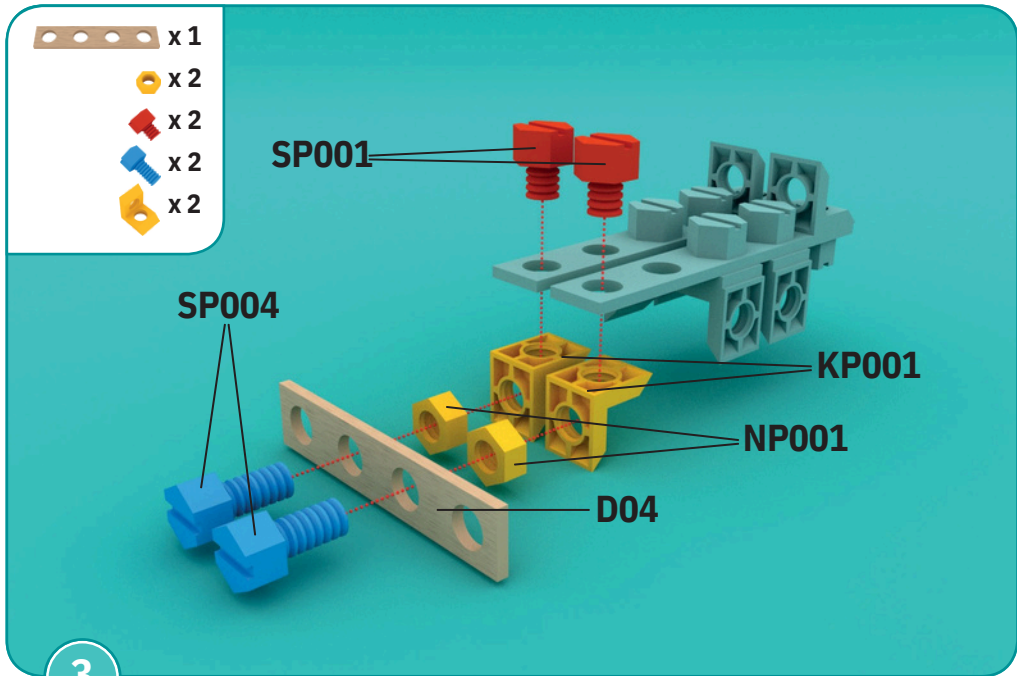

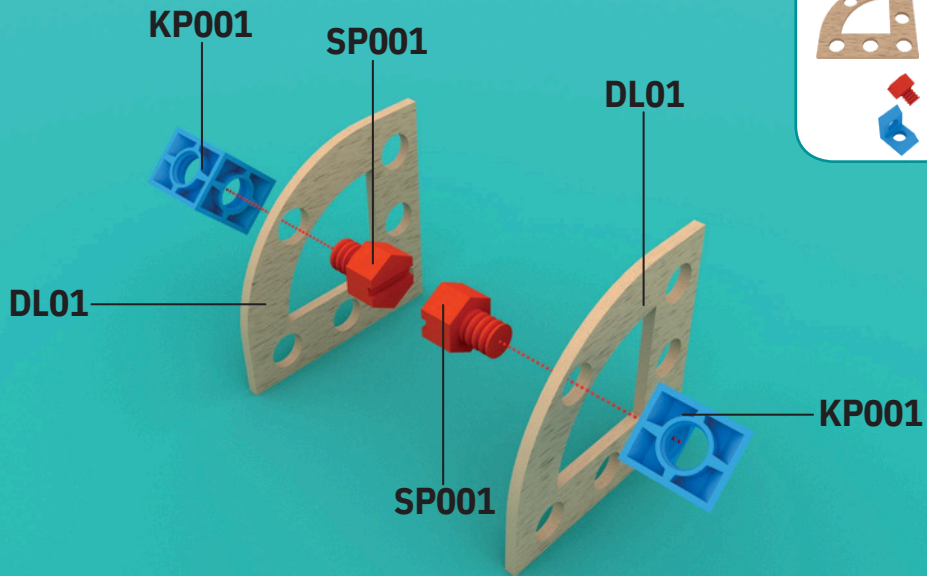
3



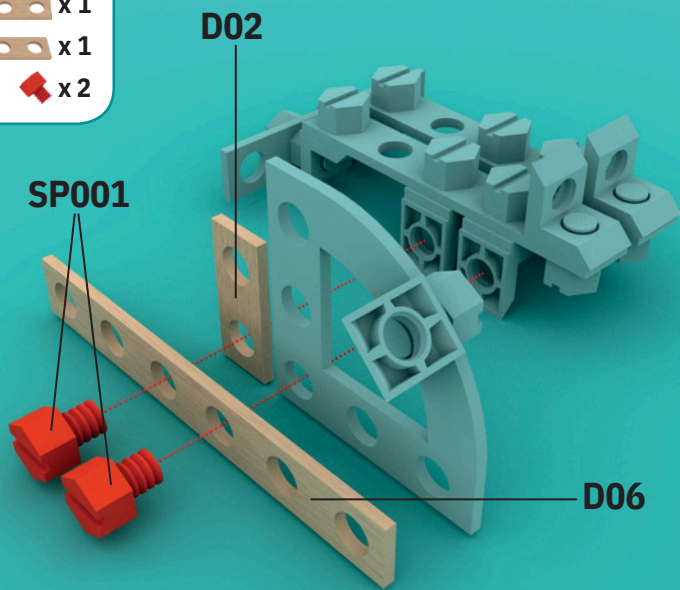

-  x 1
-  x 1
-  x 2



-  x 1
-  x 1
-  x 2

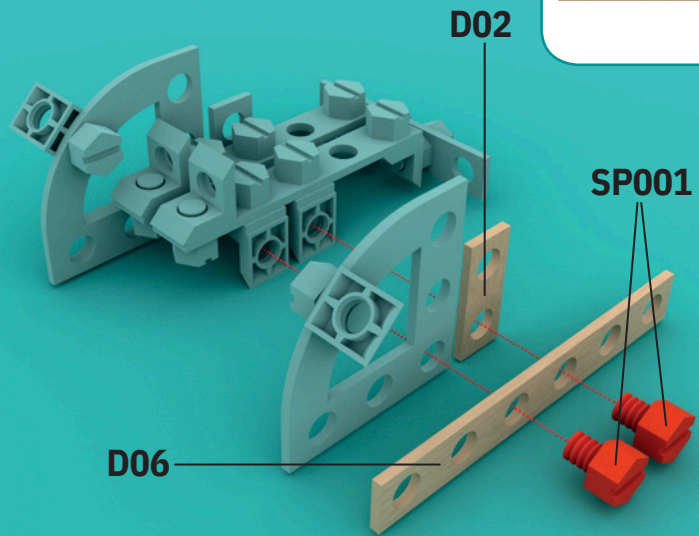

 x 8

 x 2

 x 4

 x 4

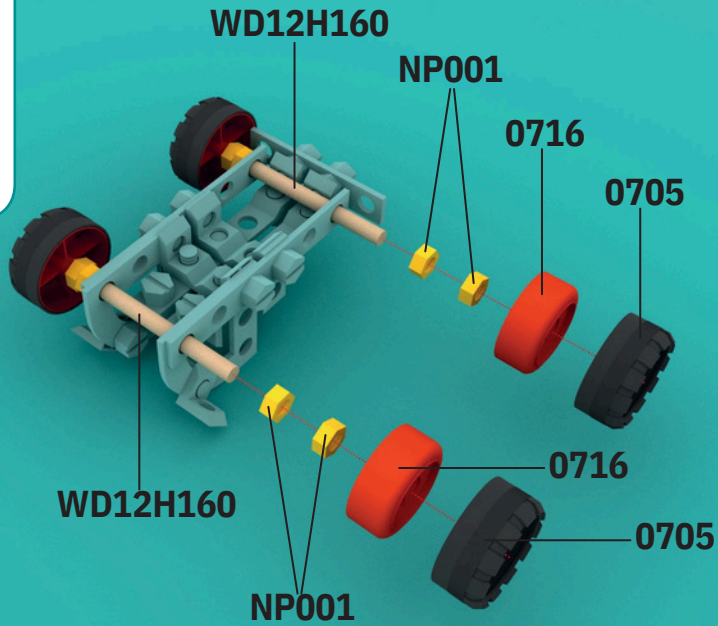

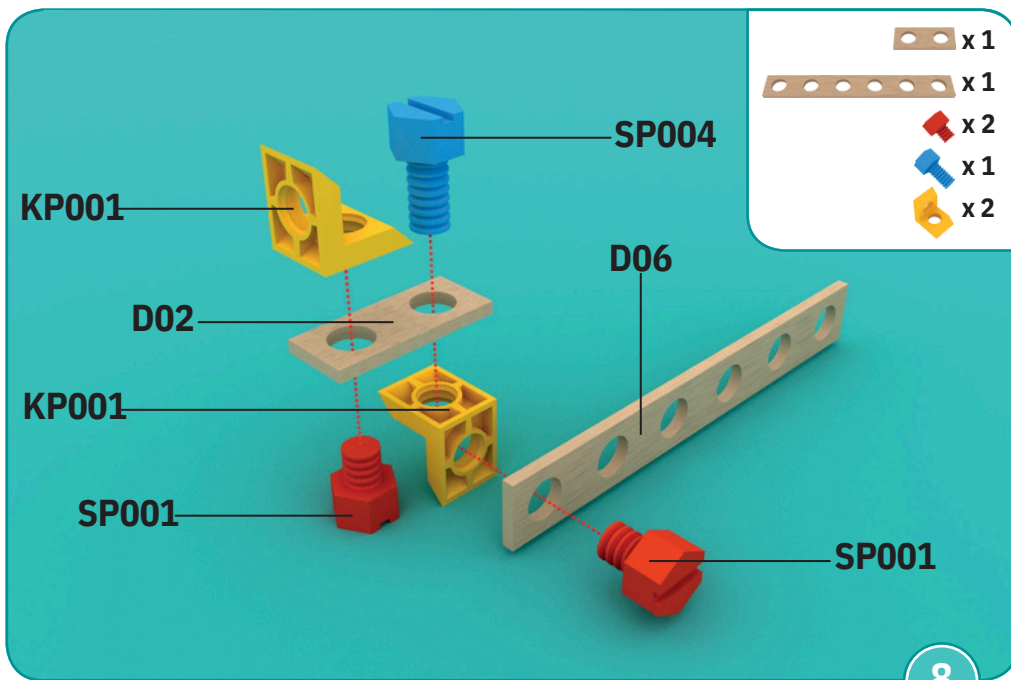



x 2



x 1



x 1

KP001

D07

SP004

9

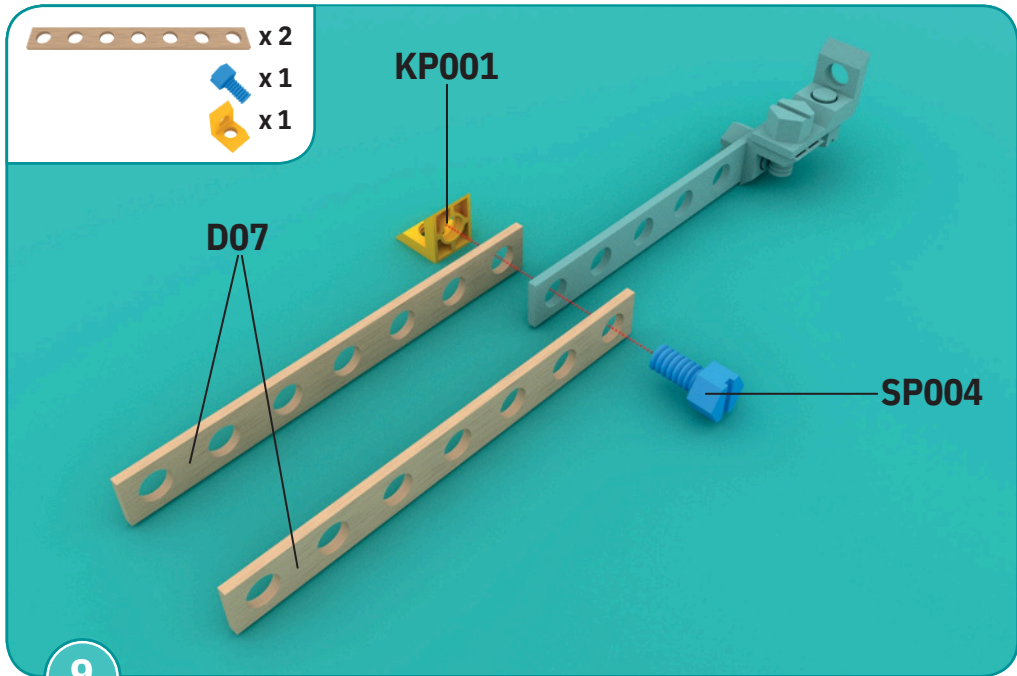

NP001 x 2

SP002

 x 4
 x 2

SP0 02

