

·MAŁY·KONSTRUKTOR·
·CONSTRUCTOR·
JUNIOR

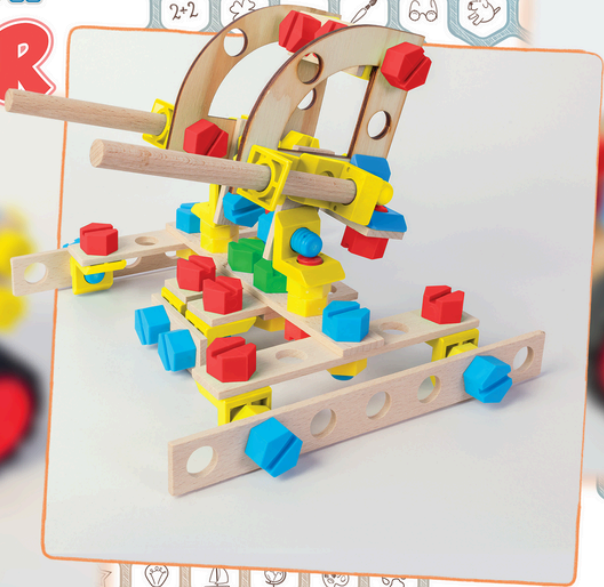

SPOSÓB UŻYCIA NARZĘDZI

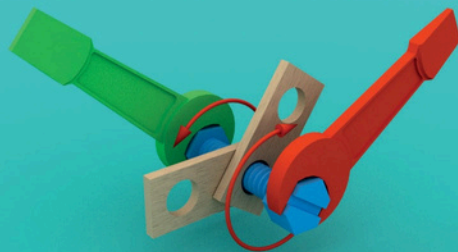

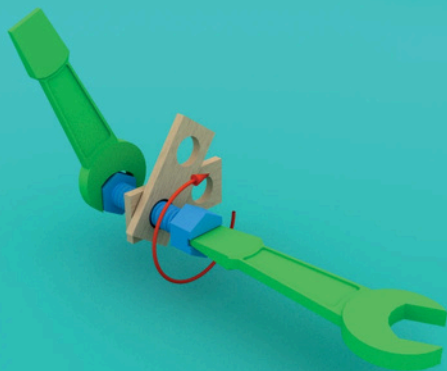

klucz x 2



D02 x 8



D06 x 1



D04 x 1



D05 x 2



D07 x 2



NP001 x 12



KP001 x 14



KP001 x 2



WD12H160 x 2



13mm
SP001 x 14



13mm
SP001 x 2



24mm
SP004 x 8



24mm
SP004 x 4

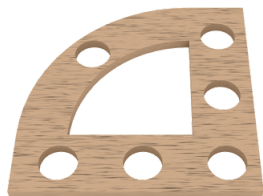

DL01 x 2



0705 x 4





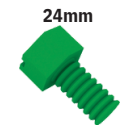

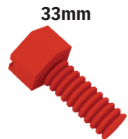

0716 x 4



24mm
SP004 x 2



33mm
SP002 x 2

-  x 1
-  x 1
-  x 2
-  x 2
-  x 2
-  x 2

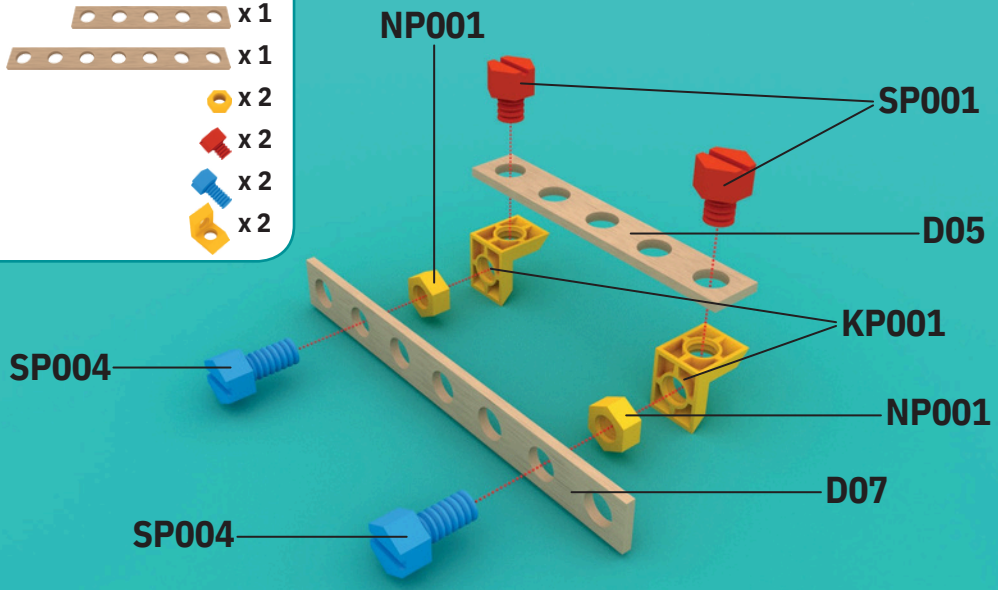

1

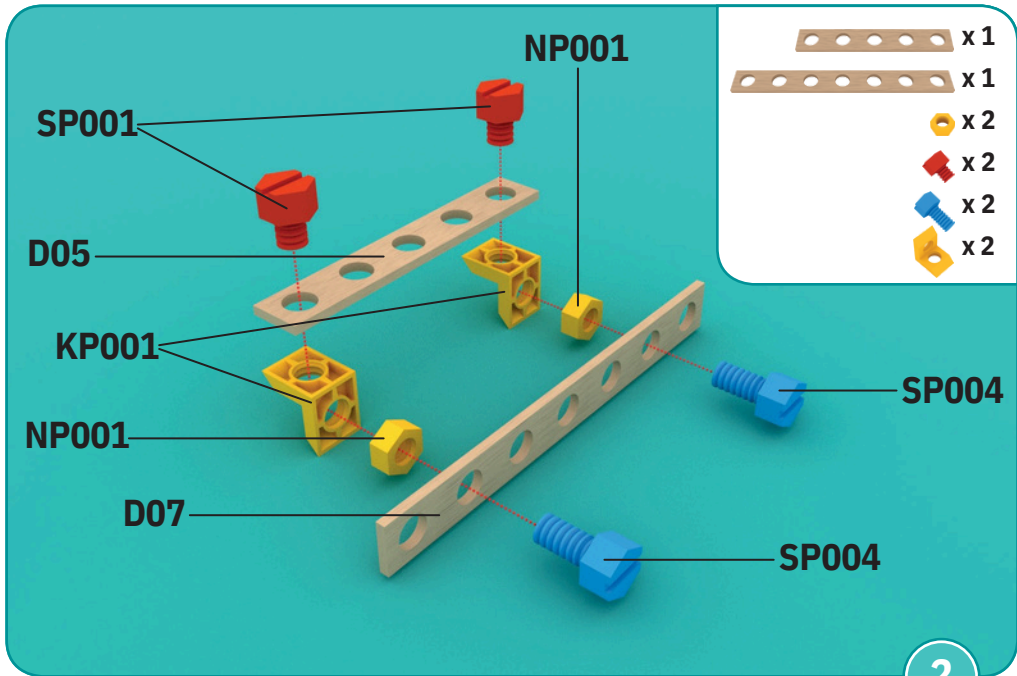

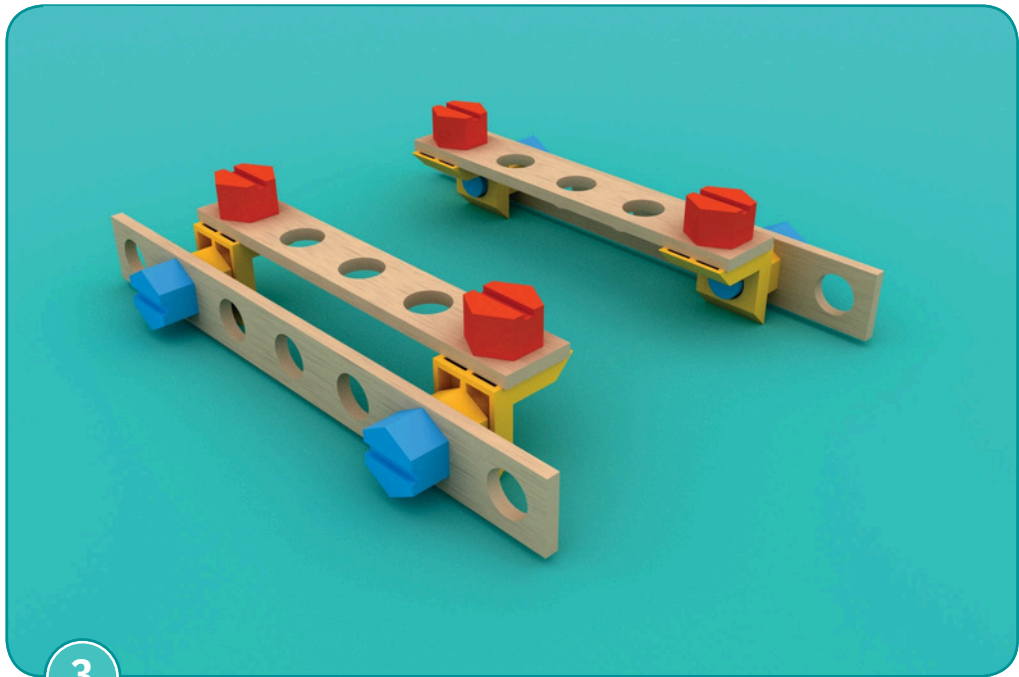

3

KP001

NP001

D06

NP001

SP0 02

x 1

x 4

x 2

x 2



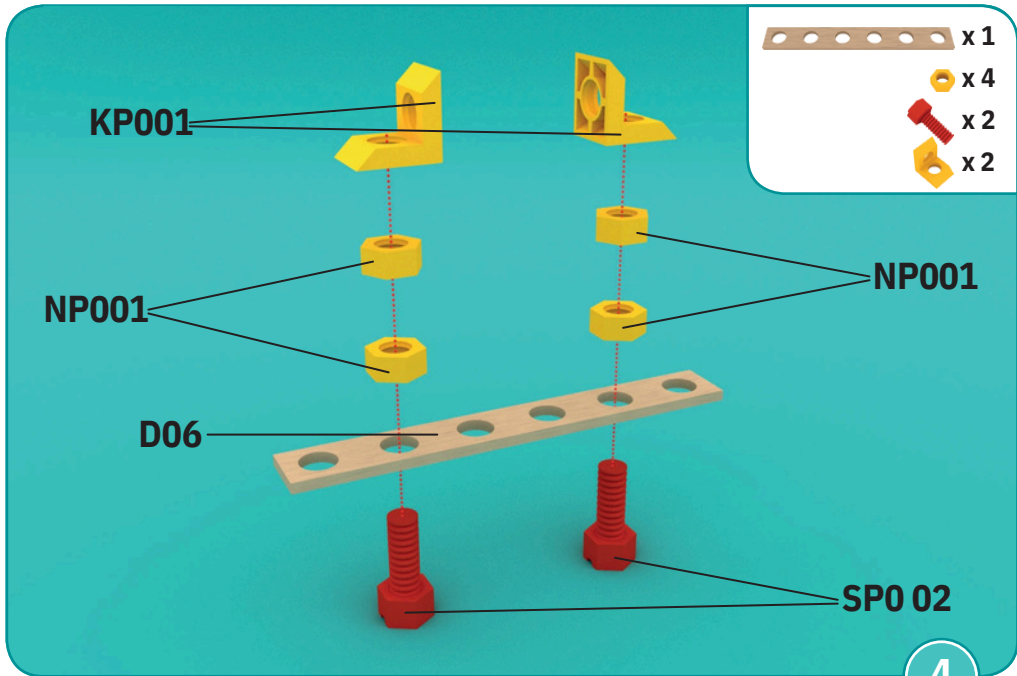

4

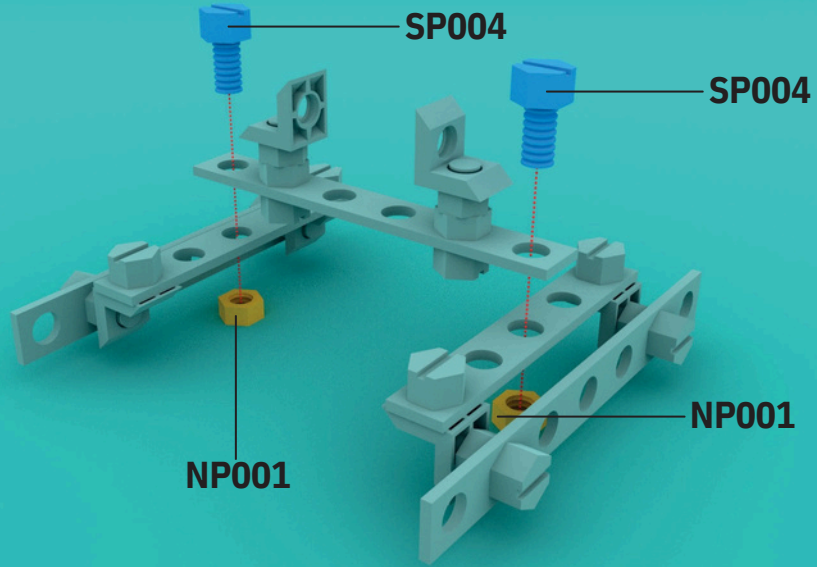

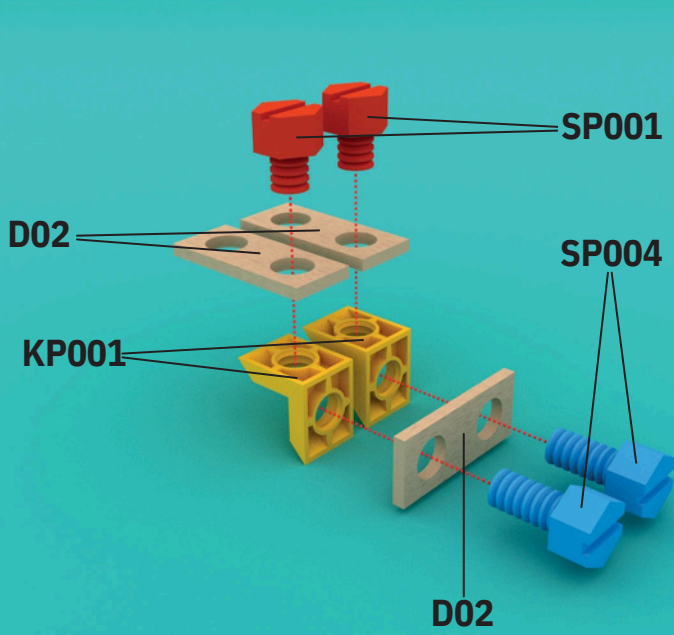
-  x 2
-  x 2





-  x 3
-  x 2
-  x 2
-  x 2

 x 2

 x 2

 x 2

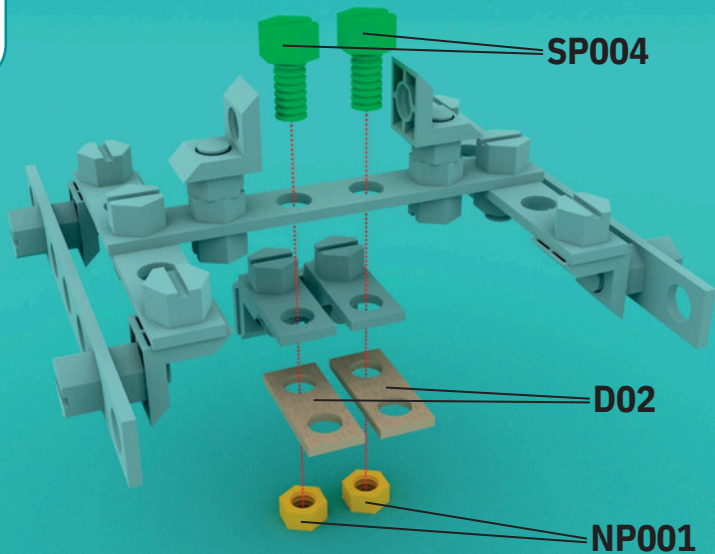

7

KP001



D02

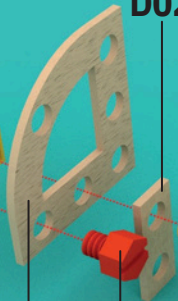

DL01

SP004

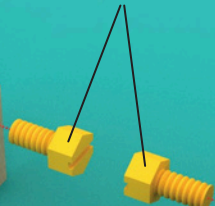

D02



DL01

SP001

SP001



x 2



x 1



x 2



x 2



x 4

KP001

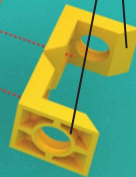

x1



x2



x2

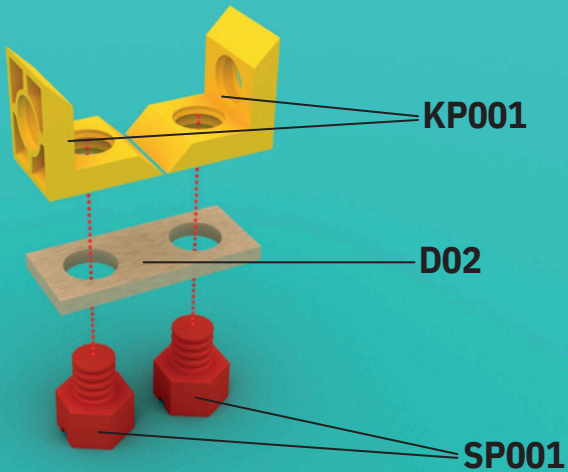

 x 2

SP001

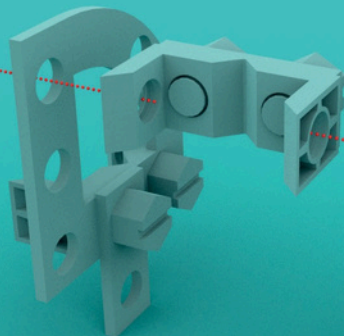
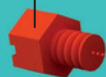

SP001



x 1

x 2

x 2

D04

KP001

SP001

11

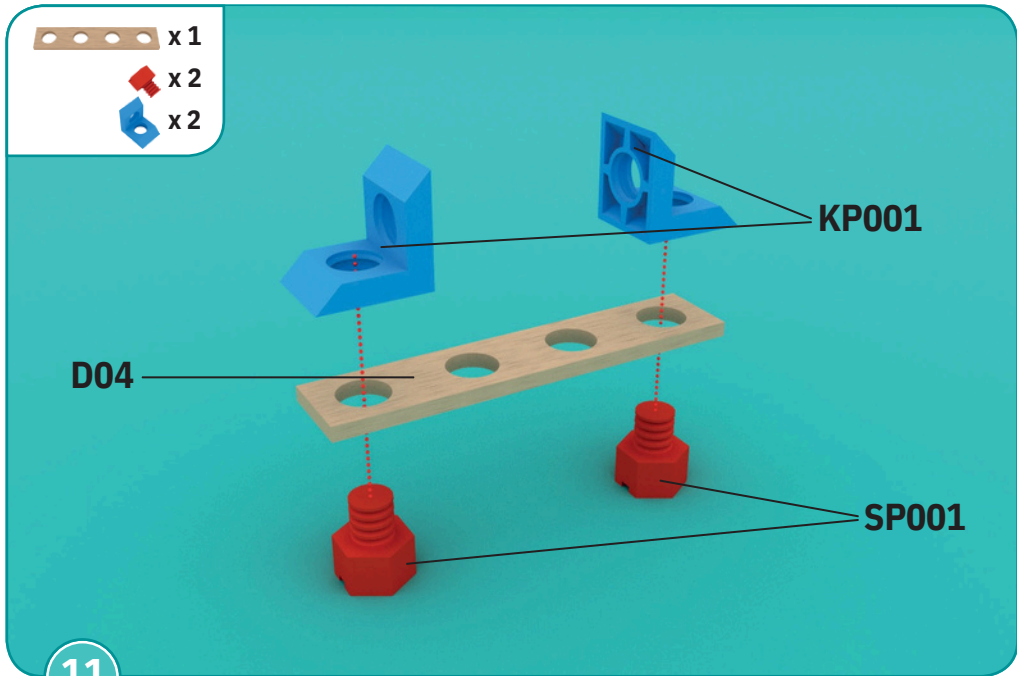

 x2

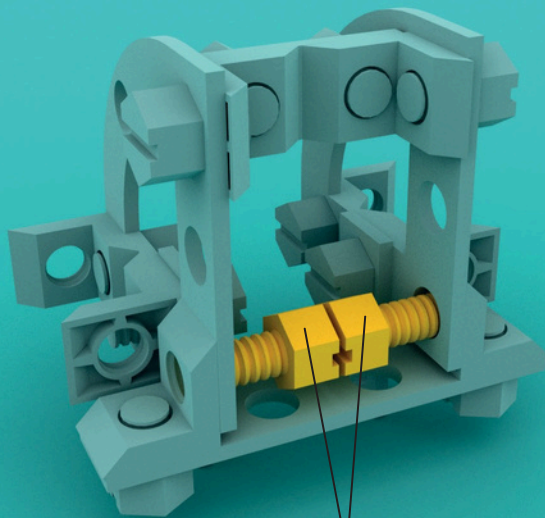

SP004

— x 2

WD12H160

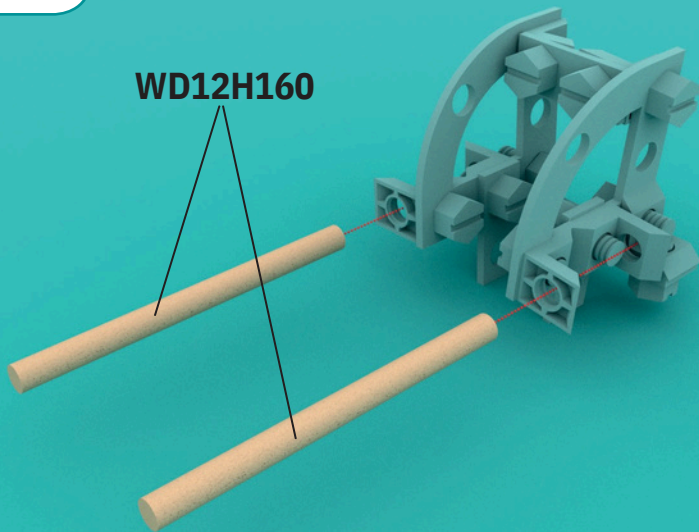

 x 2

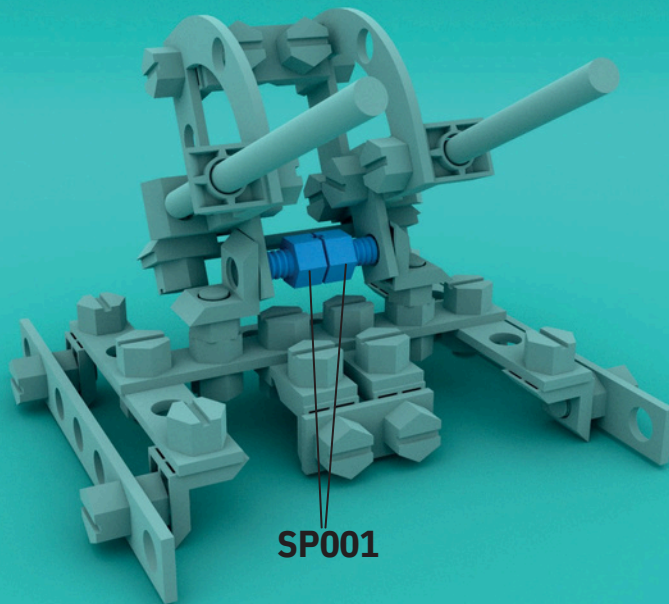

SP001



