

·MAŁY·KONSTRUKTOR·  
·CONSTRUCTOR·  
JUNIOR

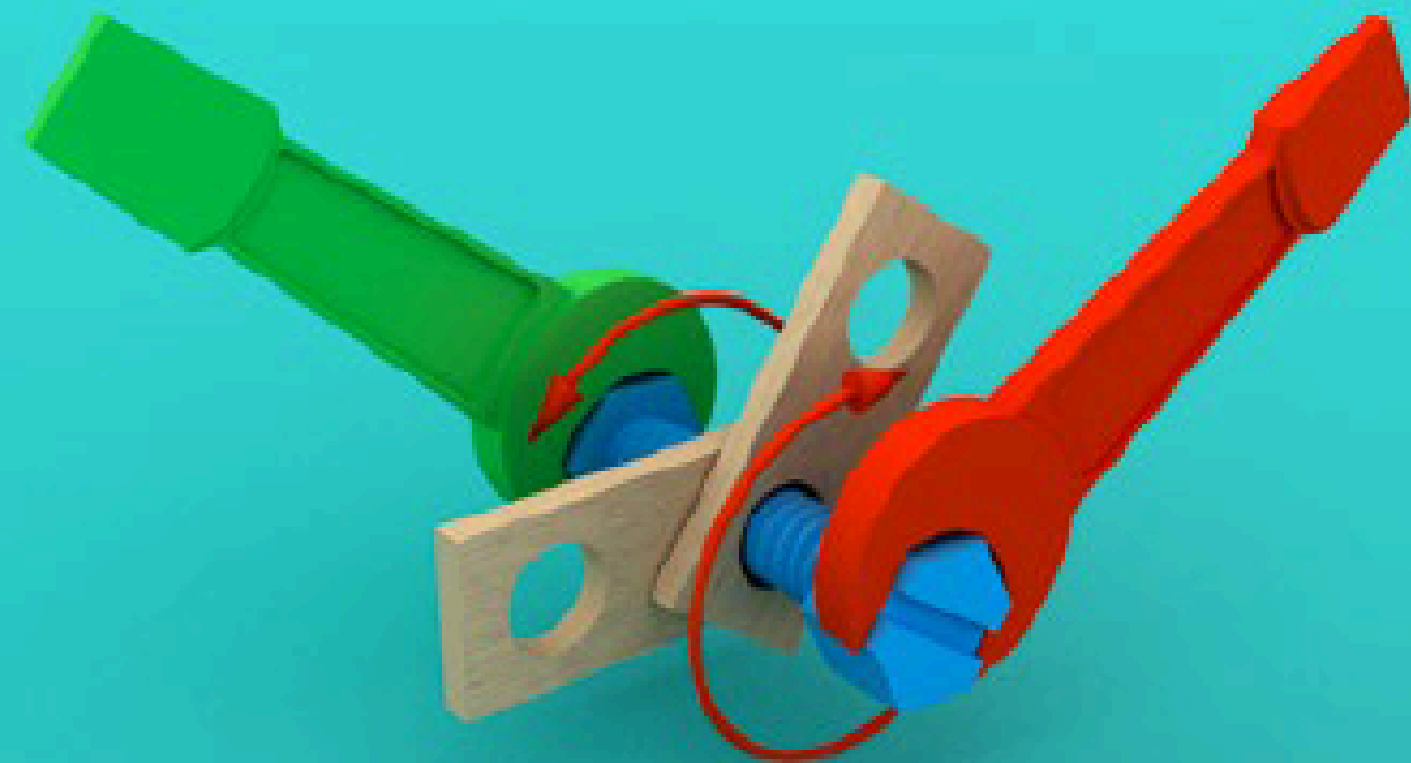

№2823

## SPOSÓB UŻYCIA NARZĘDZI

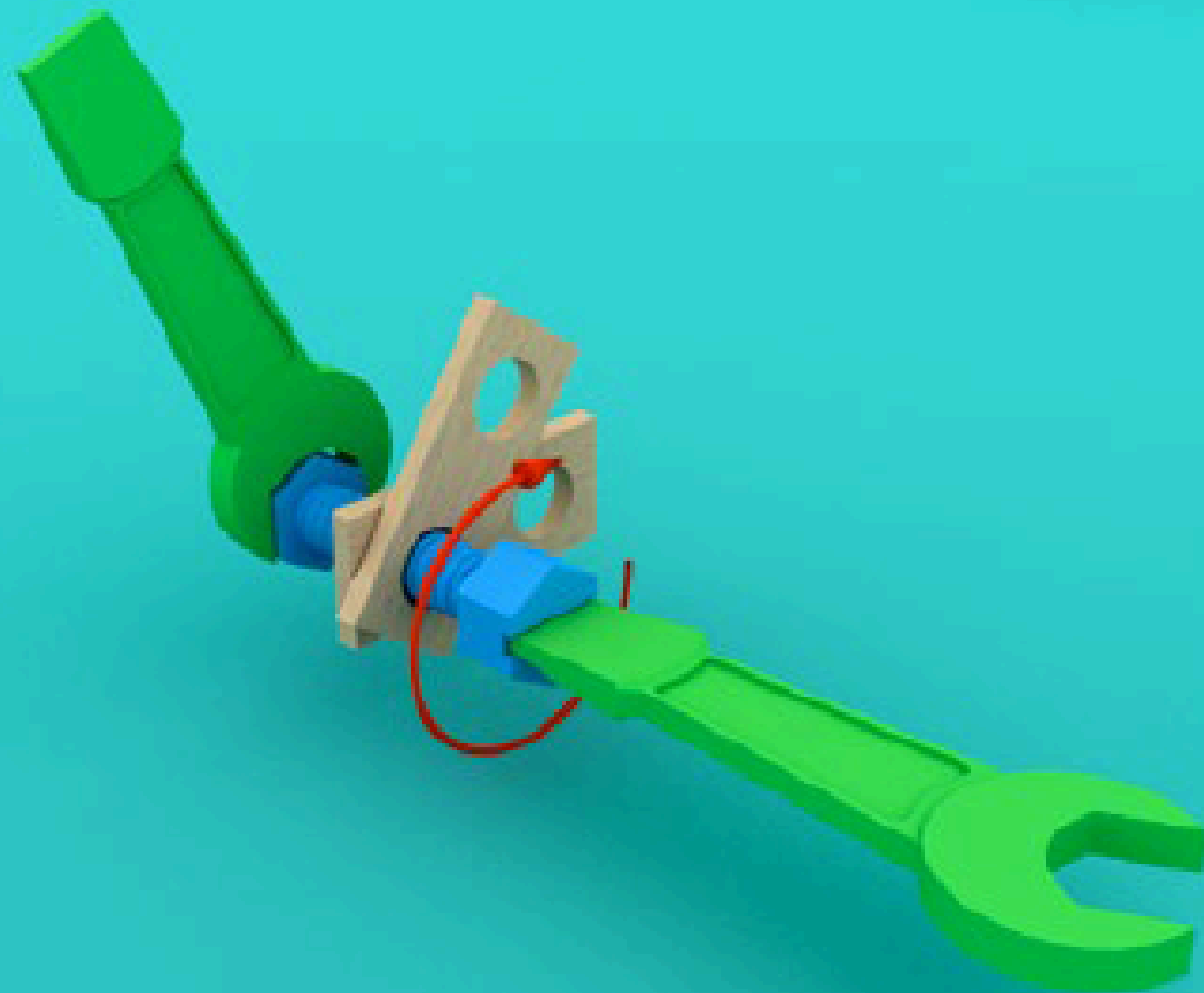

## Spis elementów do montażu:

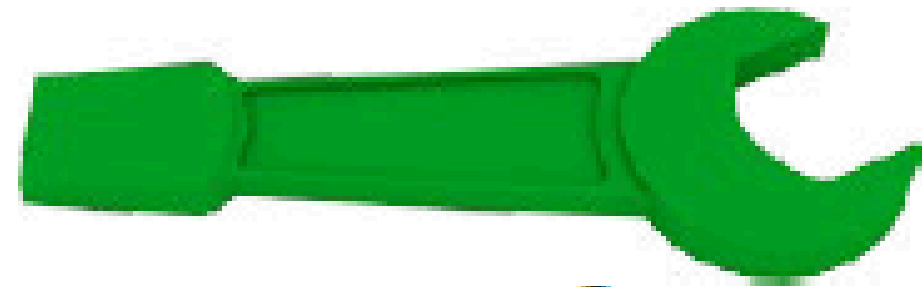

klucz x 2

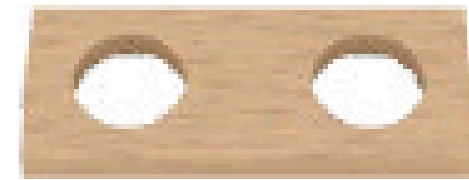

D02 x 2

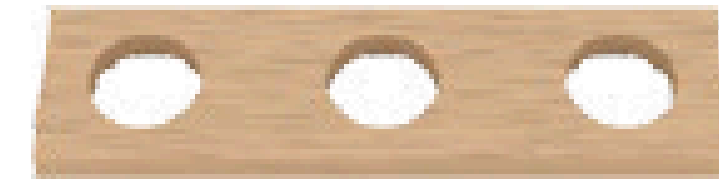

D03 x 5

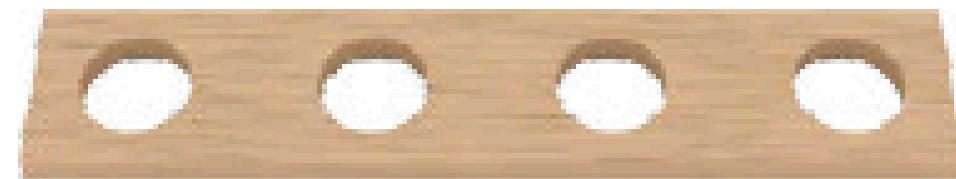

D04 x 2

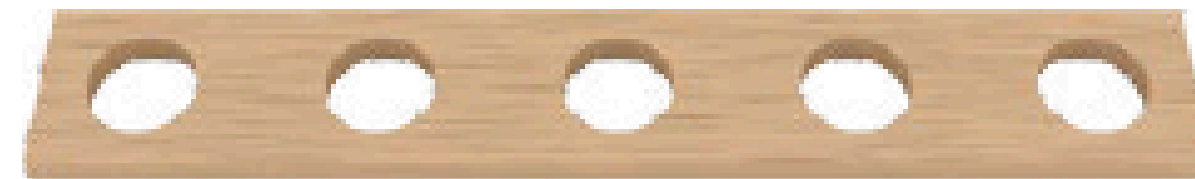

D05 x 3



WD12H160 X 2



0705 X 4

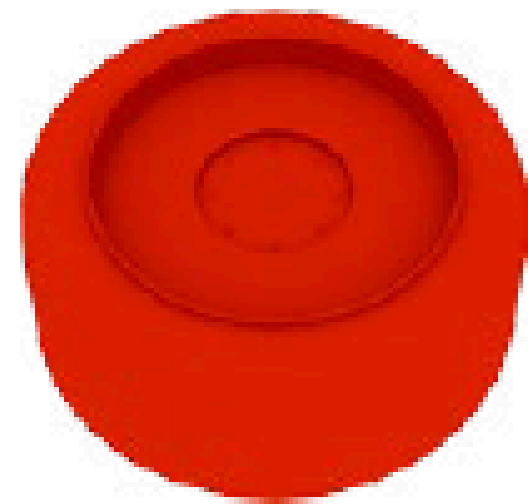

0716 X 4

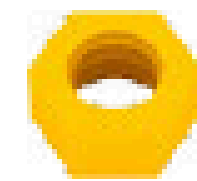

NP001 x 25

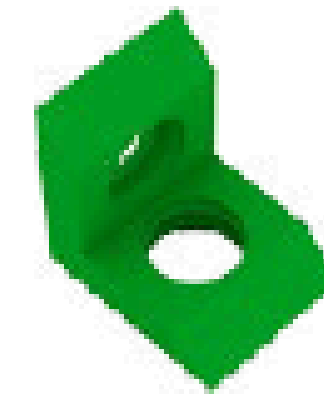

KP001 x 11



SP001 x 12



SP004 x 6

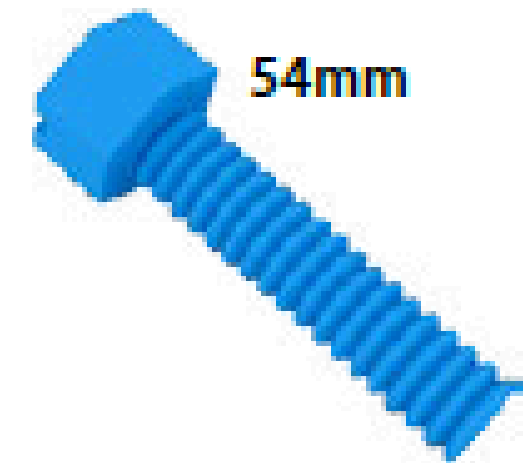

SP003 x 2

-  x 1
-  x 1
-  x 2
-  x 2
-  x 2
-  x 2

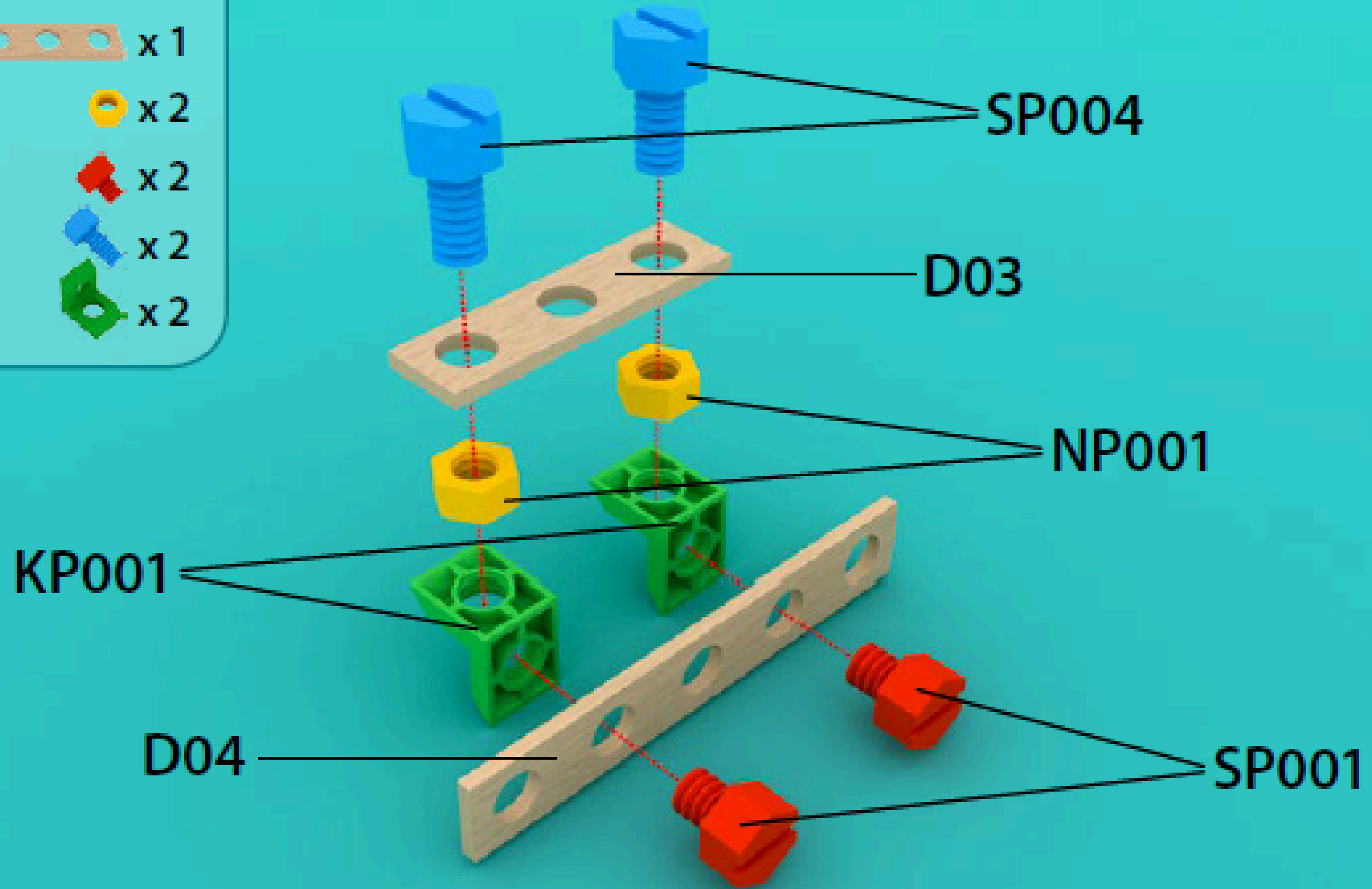

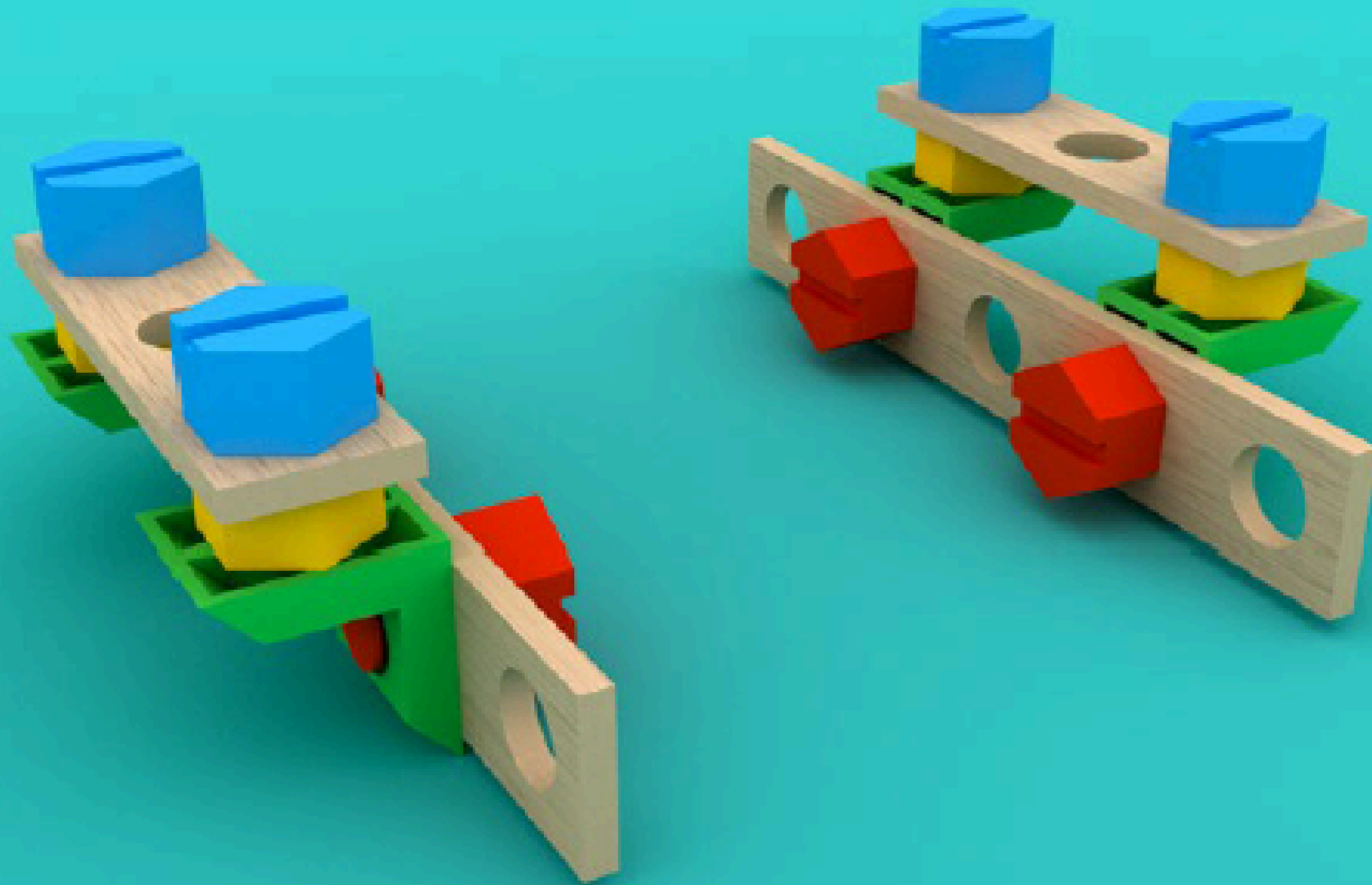

 x 2

 x 2

 x 2

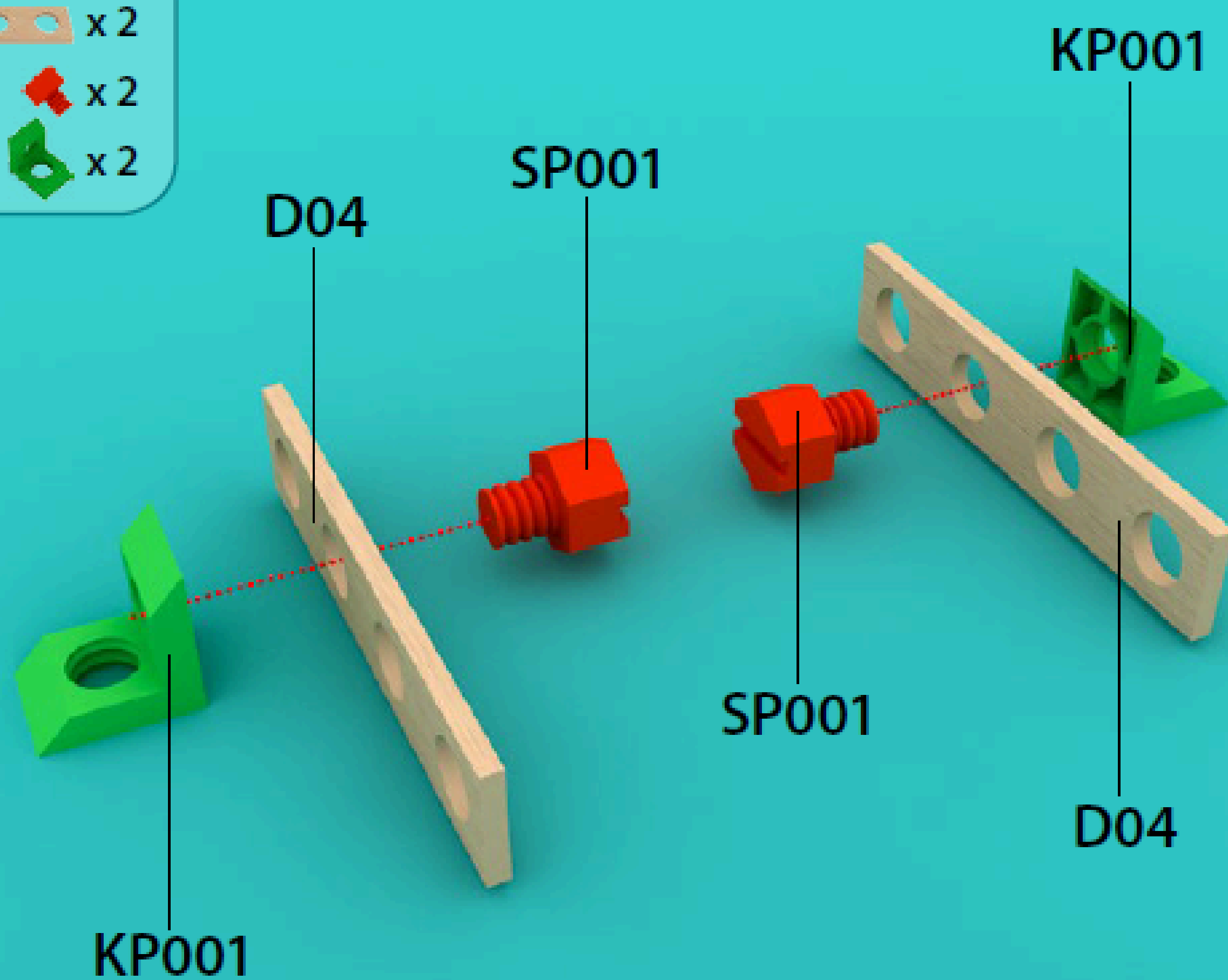

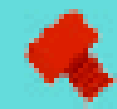
 x 2

SP001

SP001

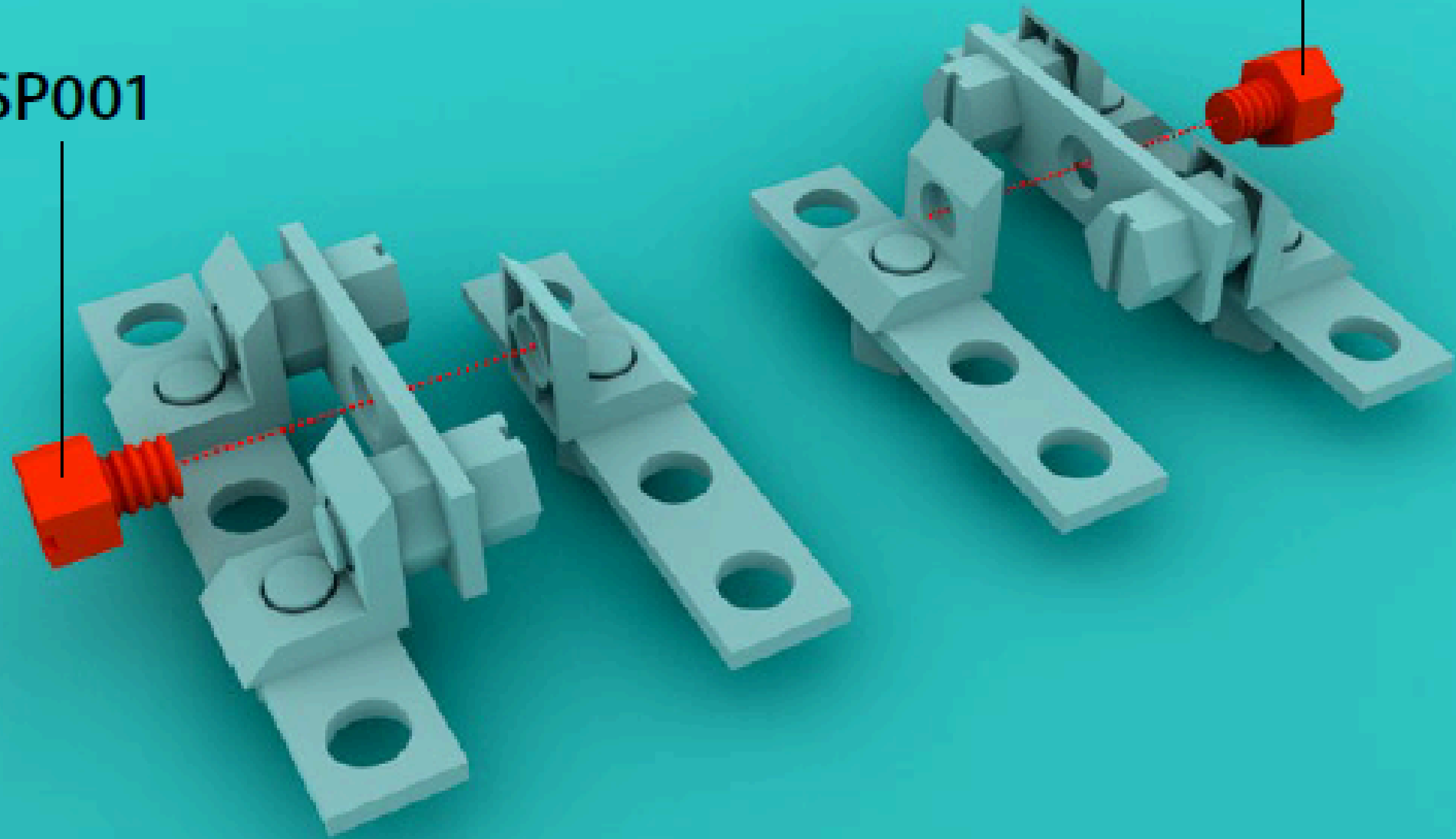

-  x 1
-  x 1
-  x 2

SP003

KP001

NP001

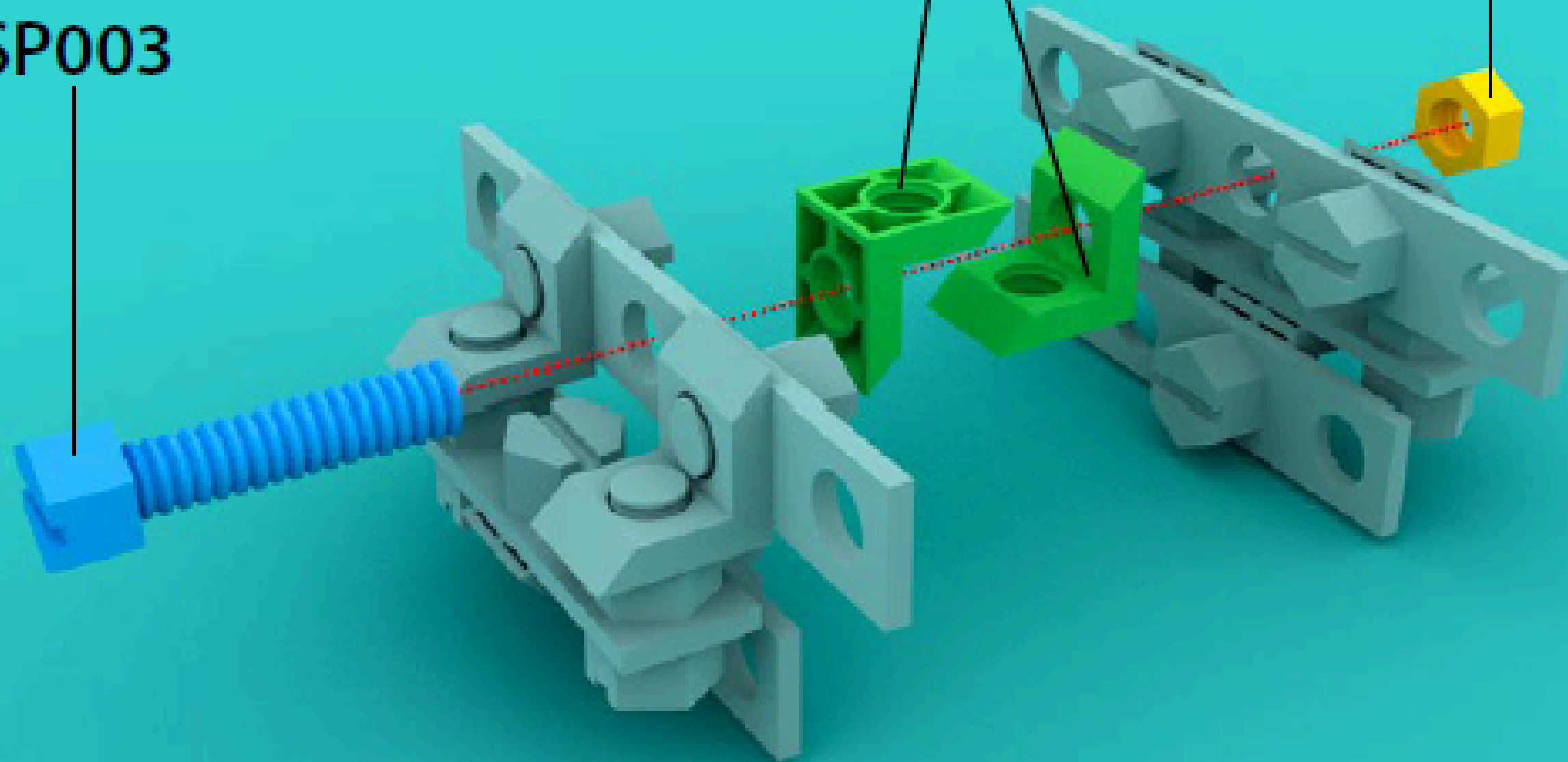



-  x 1
-  x 1
-  x 2

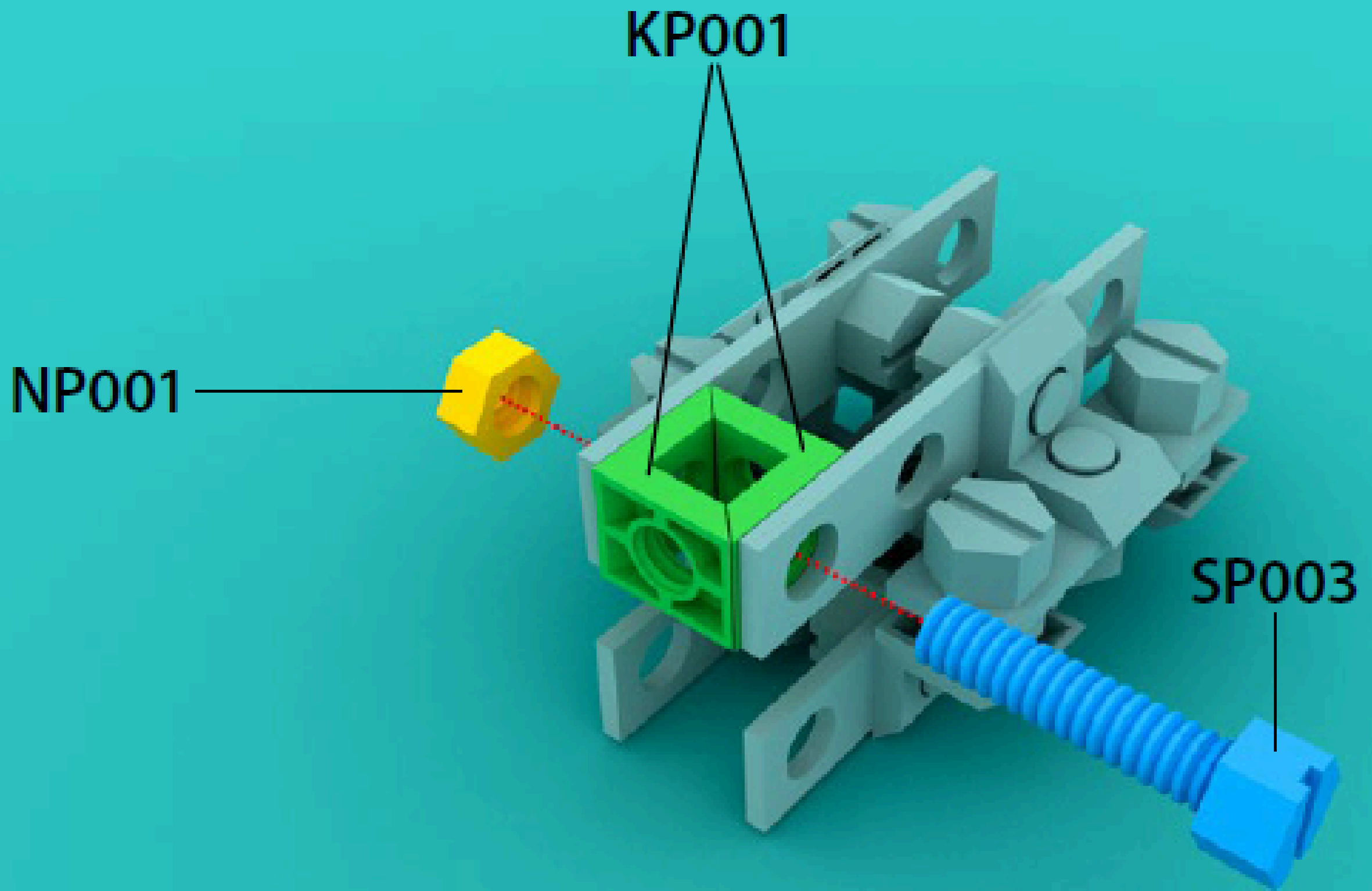

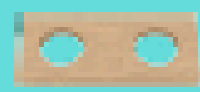
 x 2

 x 1

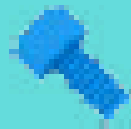
 x 1

SP004

D02

D03

7

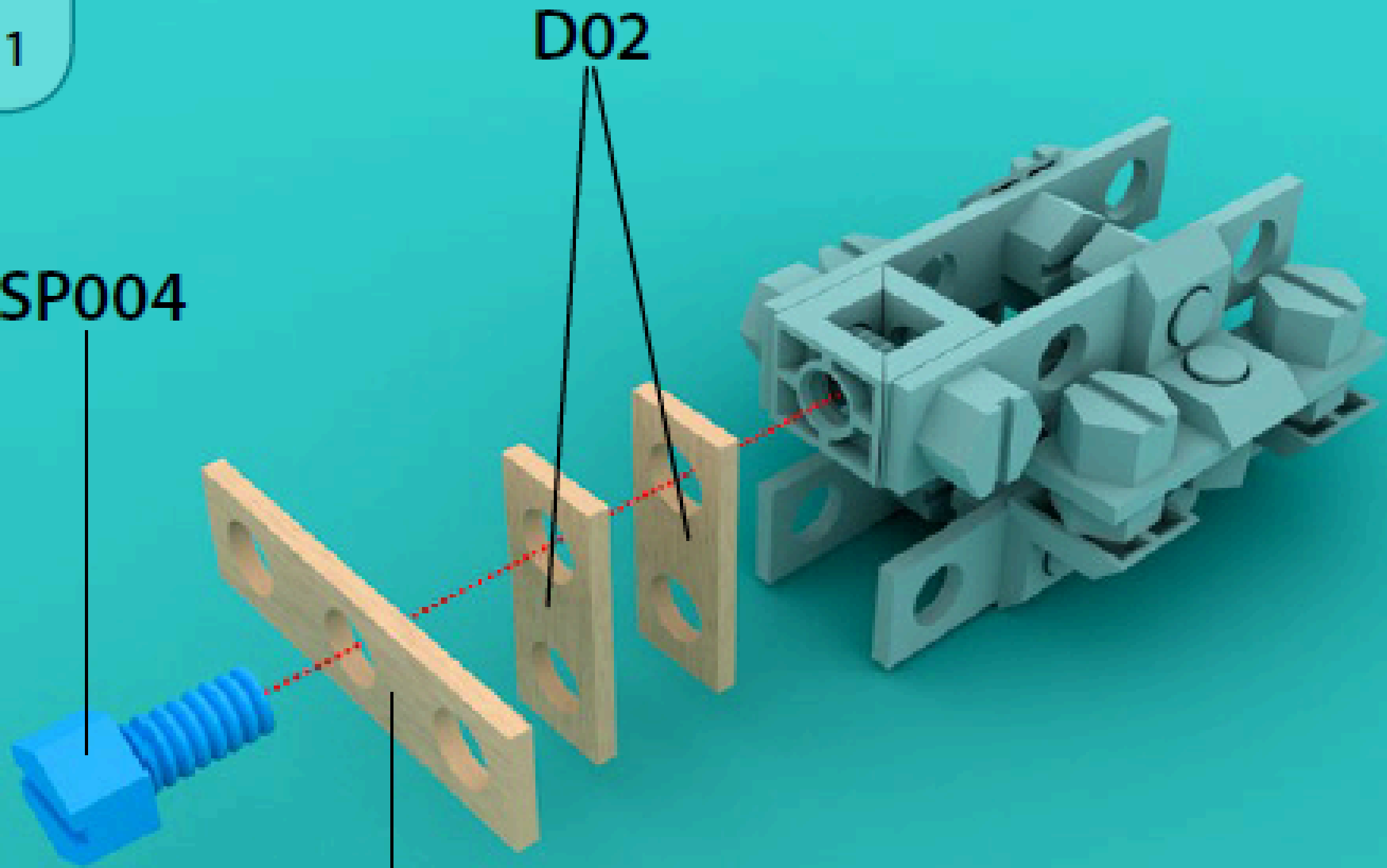





-  x 1
-  x 2
-  x 2

SP001

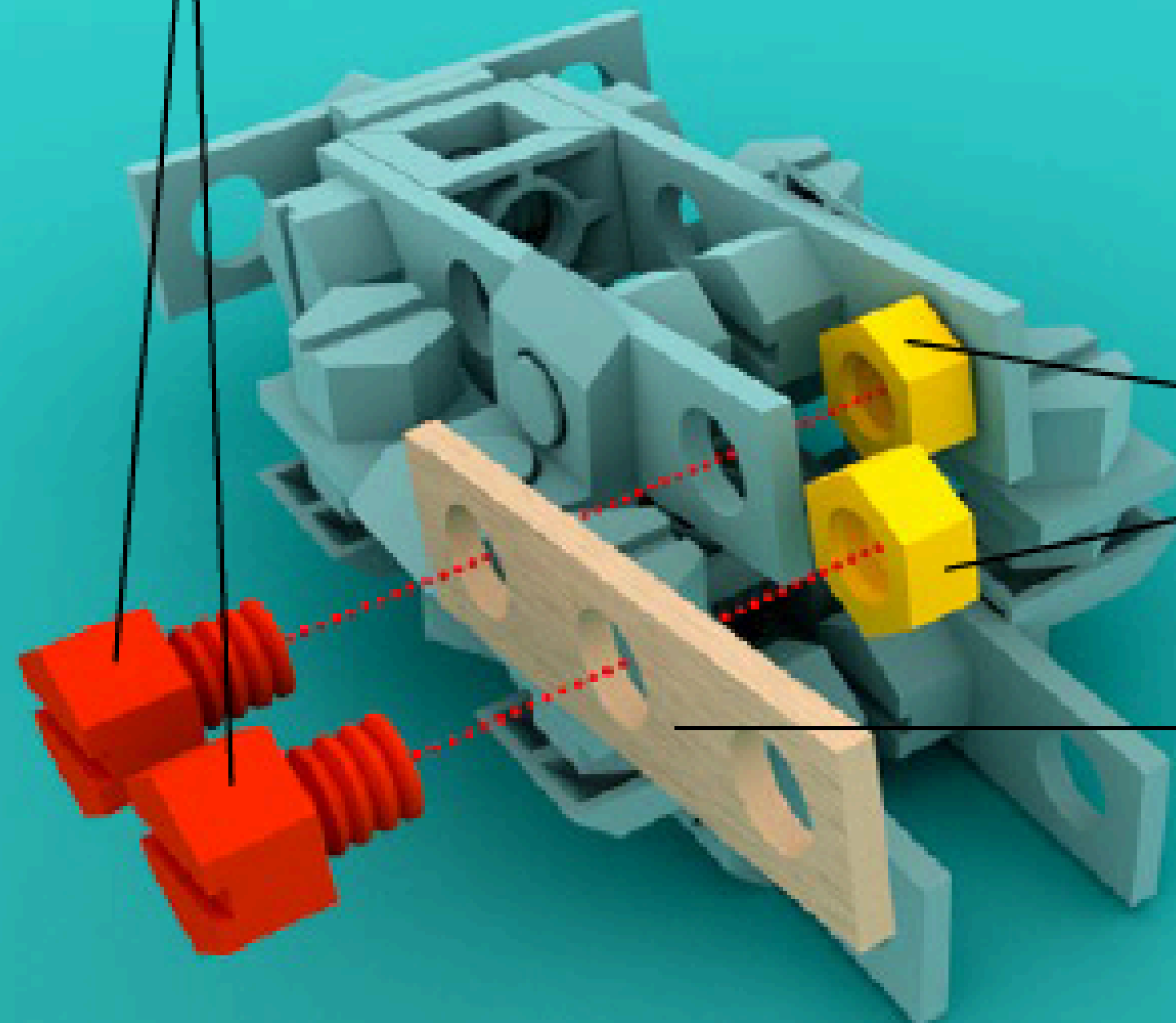
NP001

D03

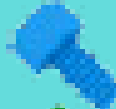
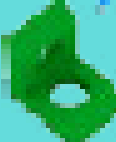

-  x 1
-  x 1
-  x 1
-  x 1
-  x 1

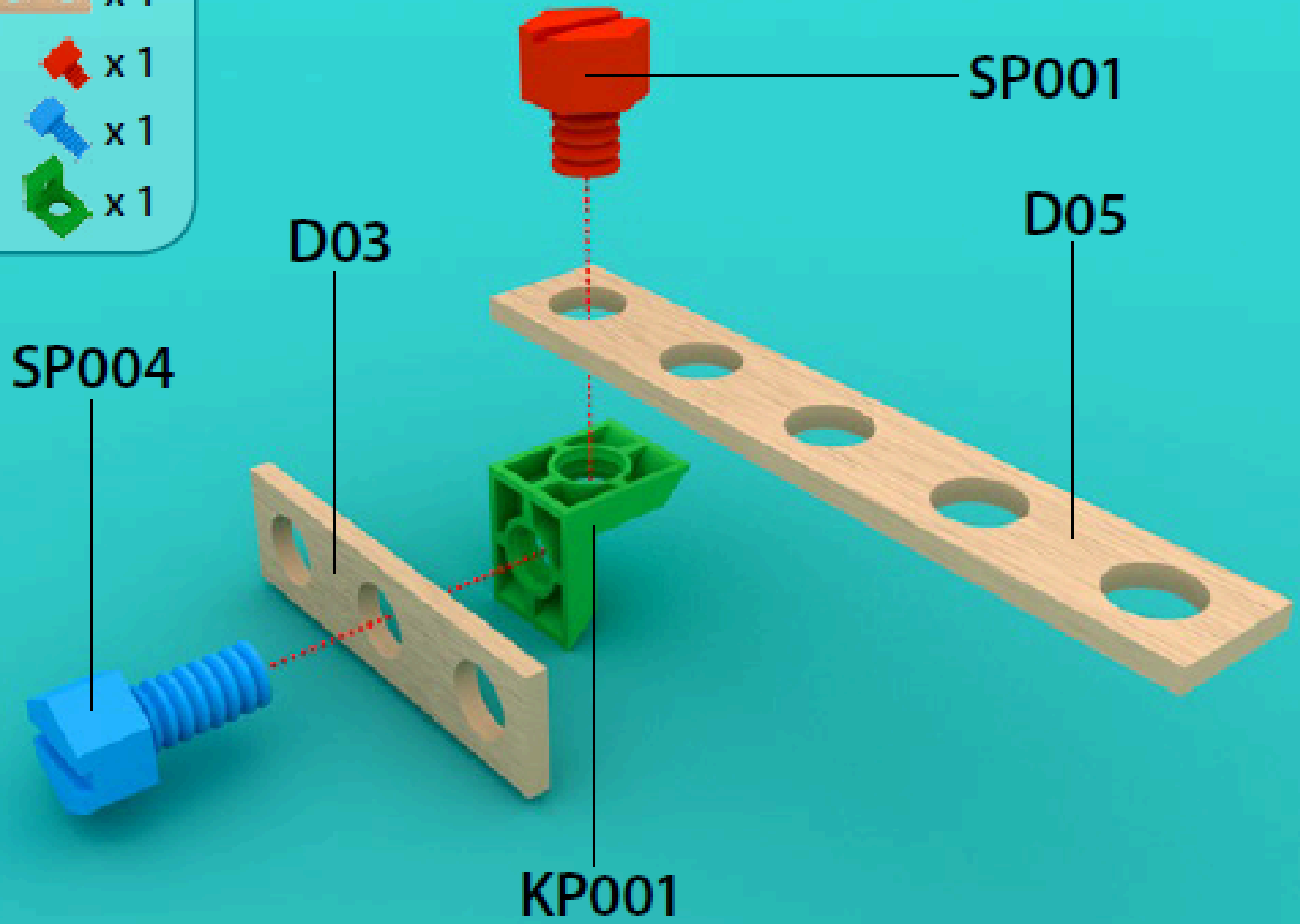

 x 1

 x 1

SP001

NP001

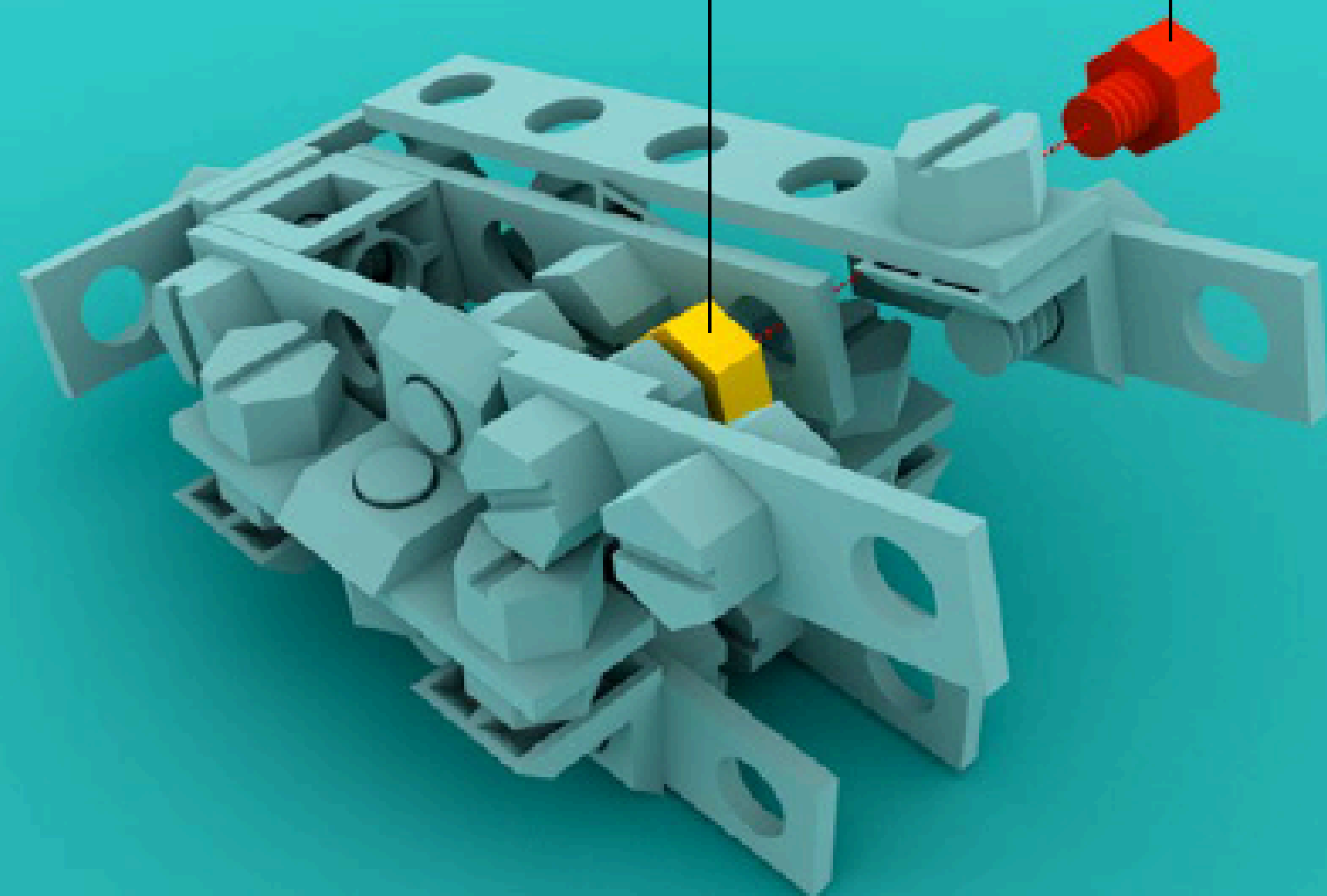

-  x 16
-  x 2
-  x 4
-  x 4

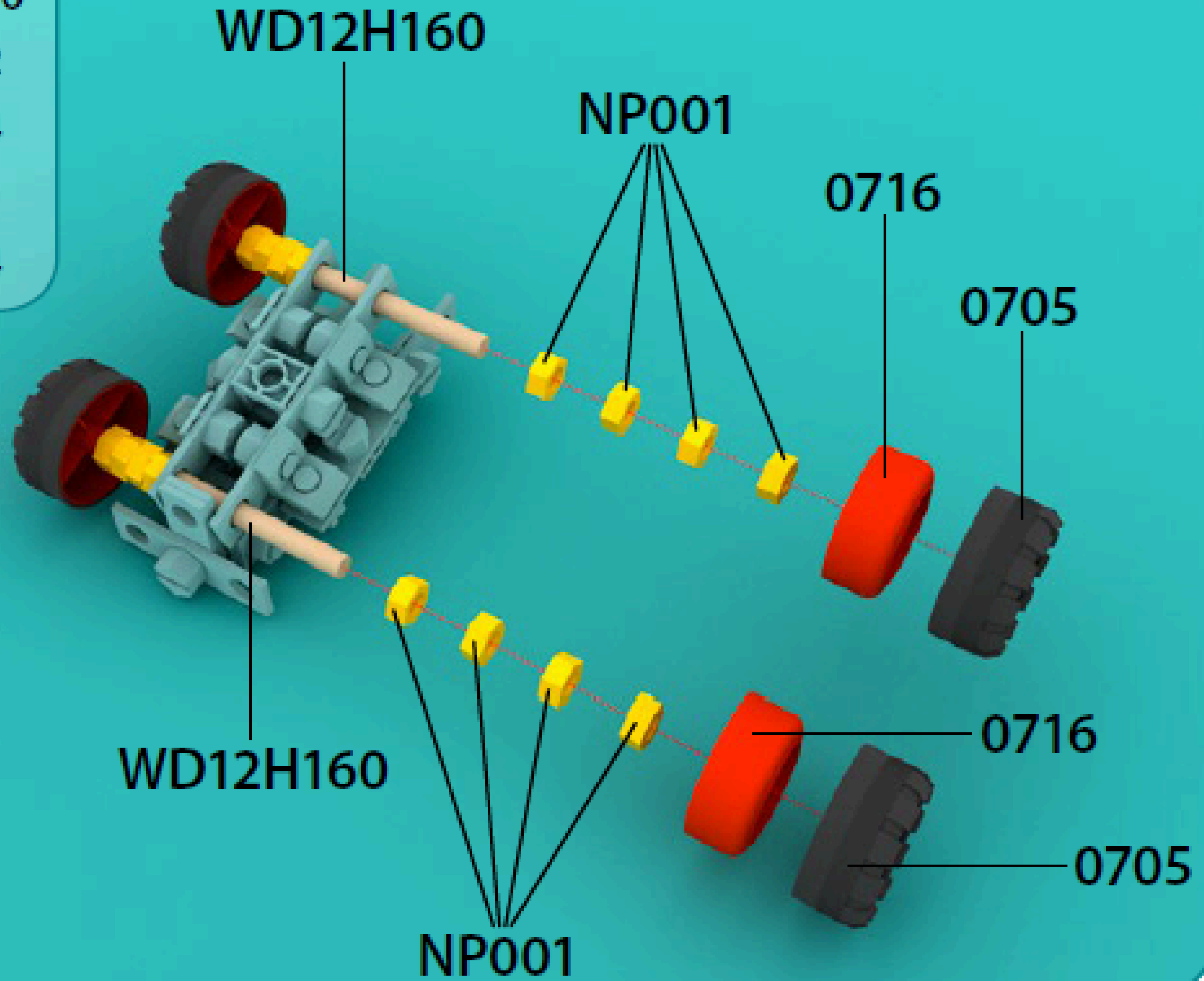

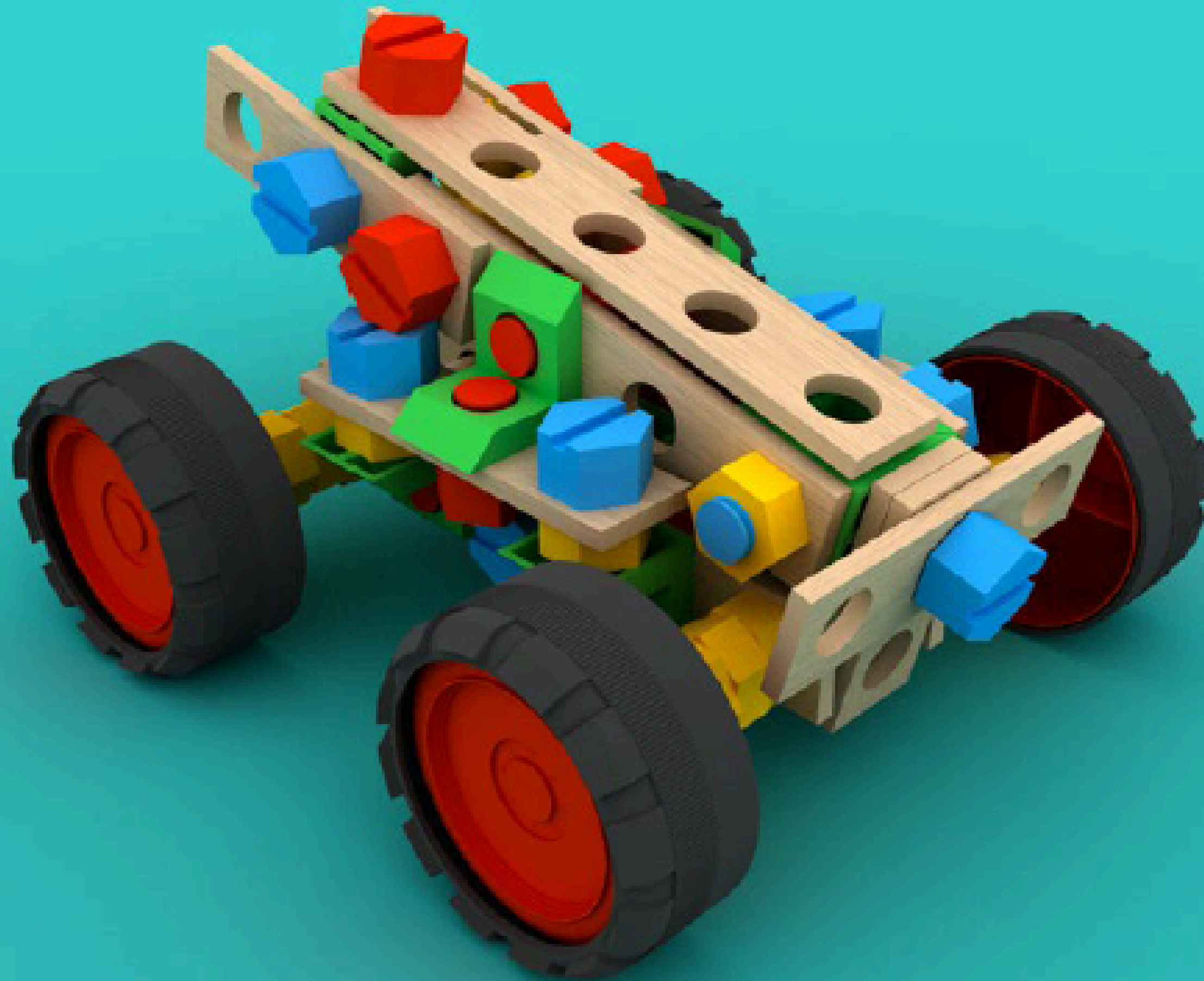

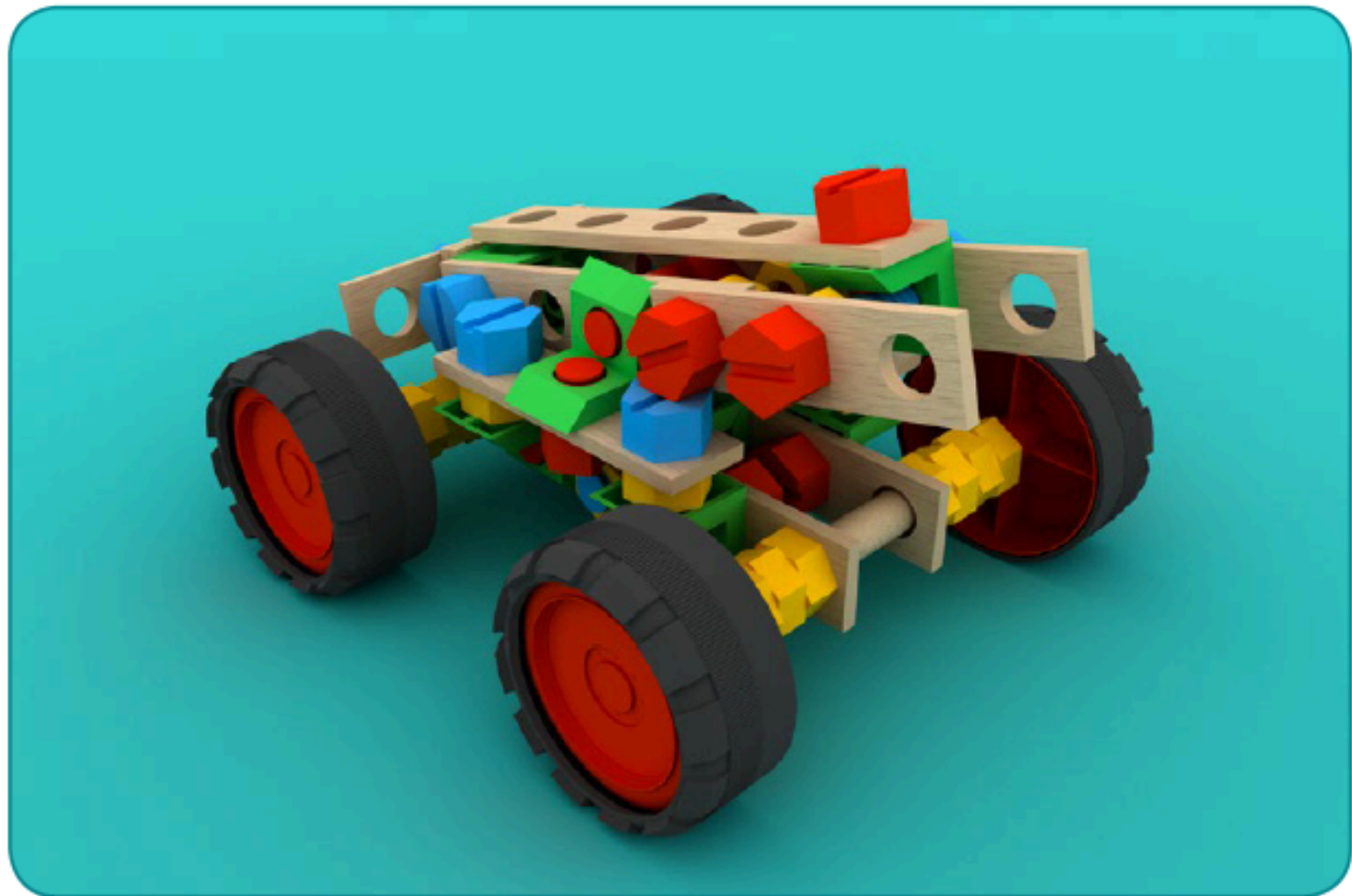
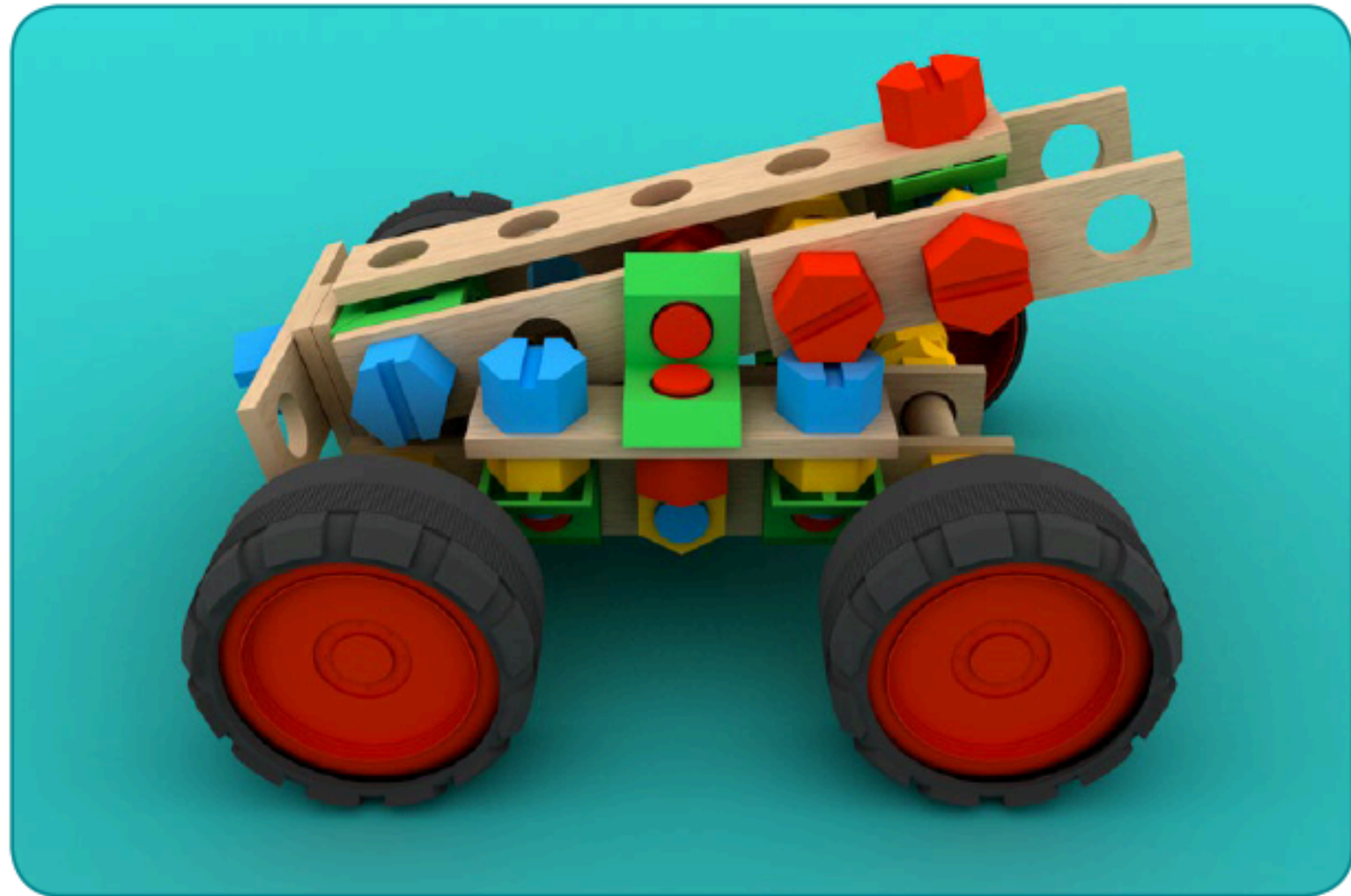
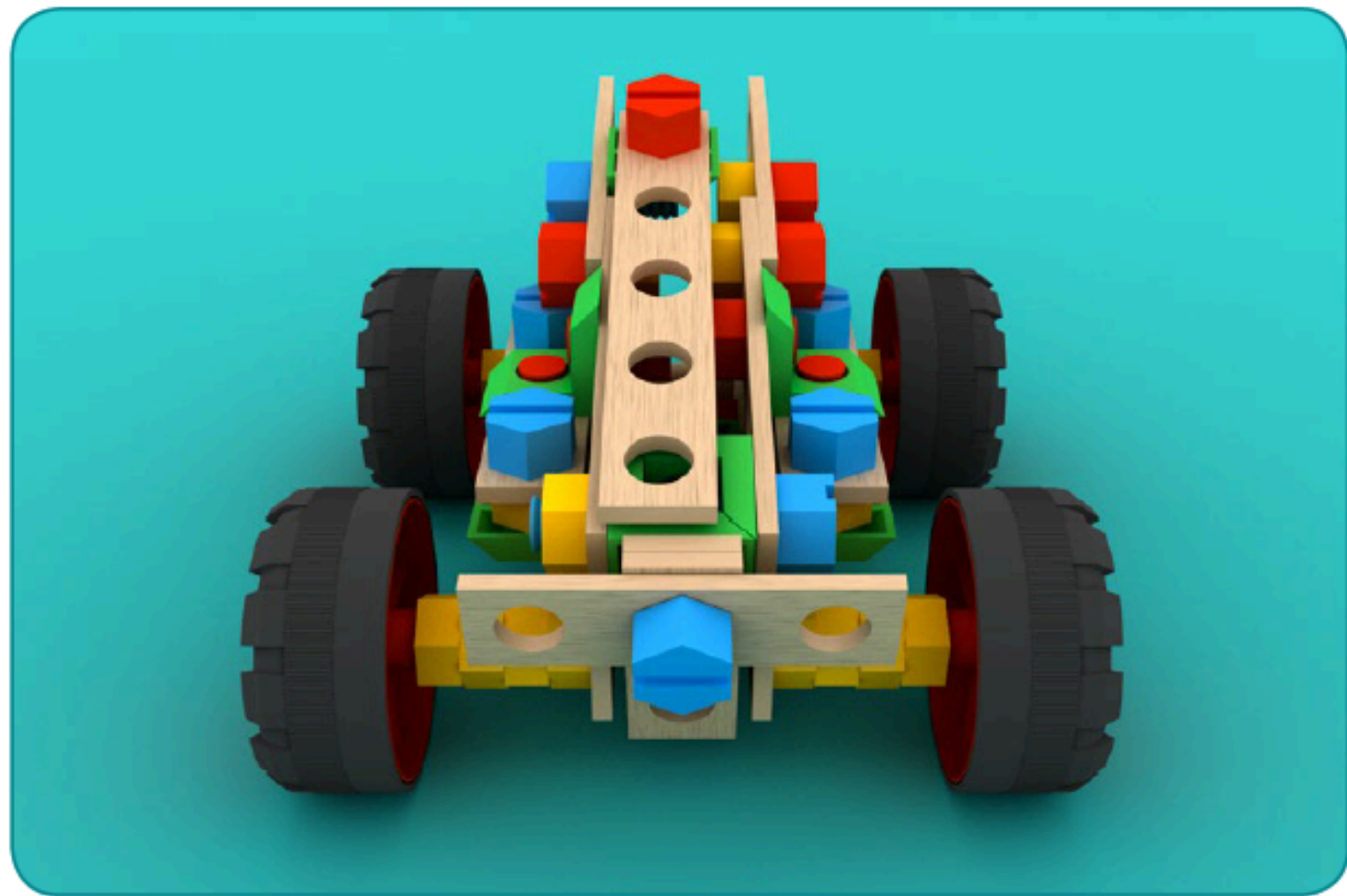



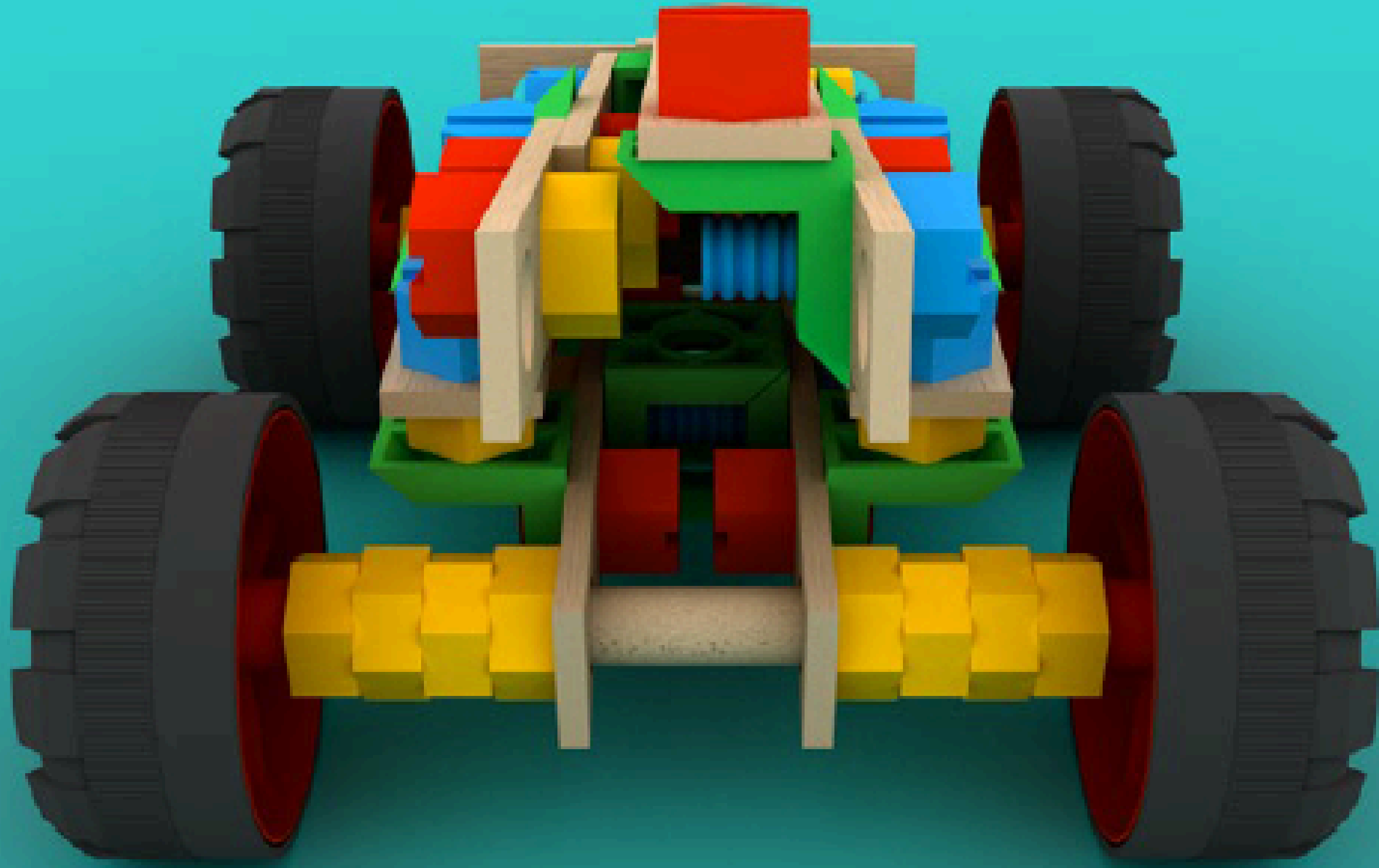

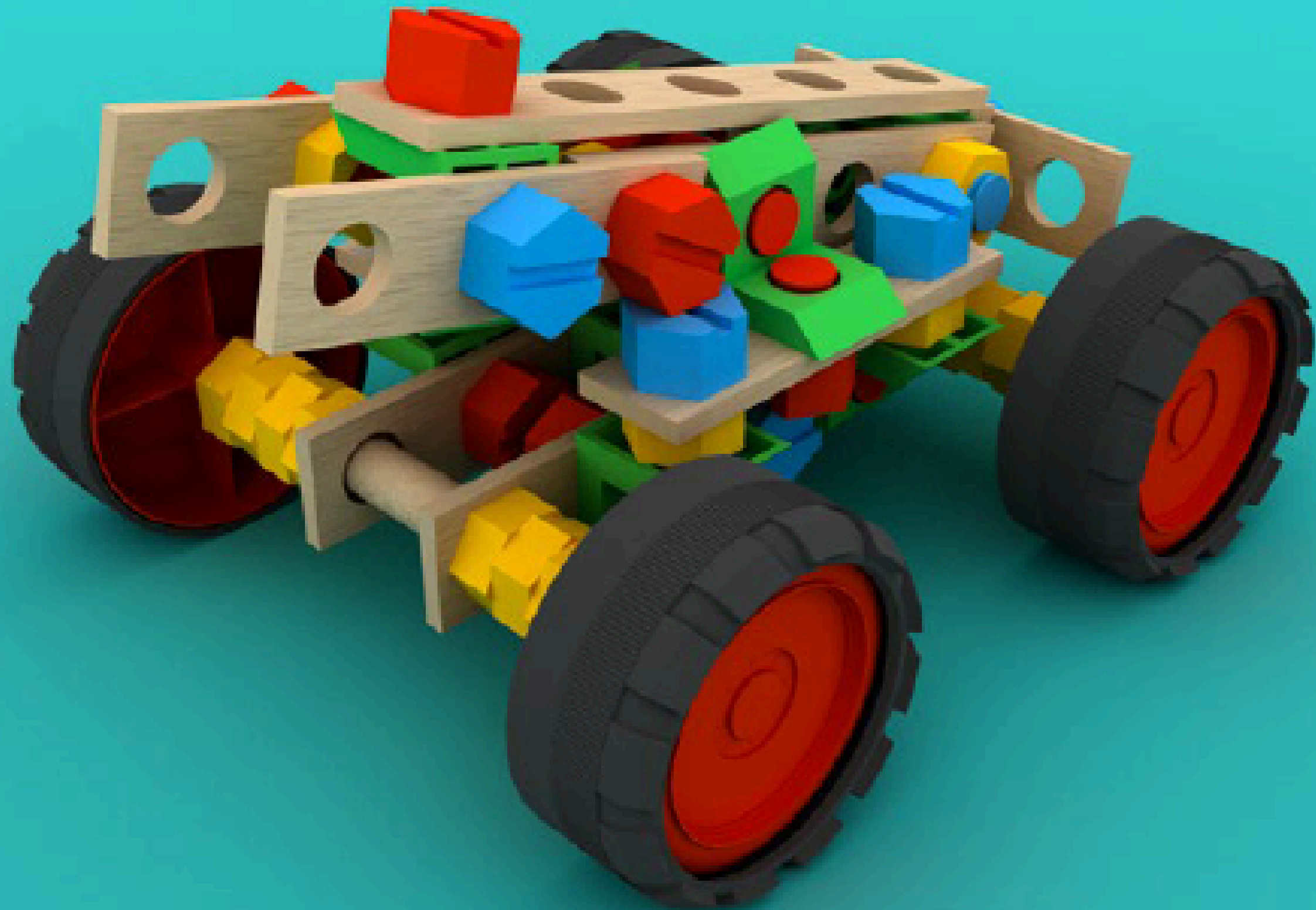

**PL:** Ostrzeżenia! Nieodpowiednie dla dzieci w wieku poniżej 3 lat. Zestaw zawiera małe elementy – niebezpieczeństwo zakrztuszenia. Prosimy zachować opakowanie ze względu na podane informacje. **EN:** Warnings! Unsuitable for children under the age of 3. Contains small parts – choking hazard. Keep the box for future reference. **DE:** Achtung! Nicht für Kinder unter 3 Jahren geeignet. Enthält kleine Teile, die verschluckt werden können – Erstickungsgefahr. Verpackung für spätere Rückfragen aufbewahren. **FR:** Attention! Ne convient pas aux enfants de moins de 3 ans. Contient des petits éléments pouvant être avalés et engendrer un risque d'étouffement. Documentation à lire et à conserver pour consultation ultérieure. **ES:** ¡Advertencia! No recomendable para niños de 3 años o menores. Peligro de asfixia – piezas pequeñas. Conserve la caja para futuras referencias. **NL:** Waarschuwing! Niet geschikt voor kinderen jonger dan drie jaar. Bevat kleine onderdelen – verstikkingsgevaar opleveren. Bewaar de verpakking, er staat belangrijke informatie op. **CZ:** Upozornění! Nevhodné pro děti do 3 let. Balení obsahuje malé dílky – nebezpečí udušení. Zachovejte prosím obal ze vzhledu na uvedené informace. **SK:** Upozornenia! Nevhodné pre deti vo veku do 3 rokov. Súprava obsahuje malé casti – hrozí nebezpečenstvo udusenía. Obal uschovajte vzhľadom na dôležité informácie, ktoré sa na nom nachádzajú.



[www.alexander.com.pl](http://www.alexander.com.pl)