

·MAŁY·KONSTRUKTOR·
·CONSTRUCTOR·
JUNIOR

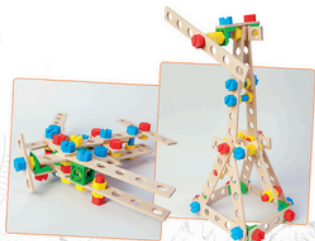

SPOSÓB UŻYCIA NARZĘDZI

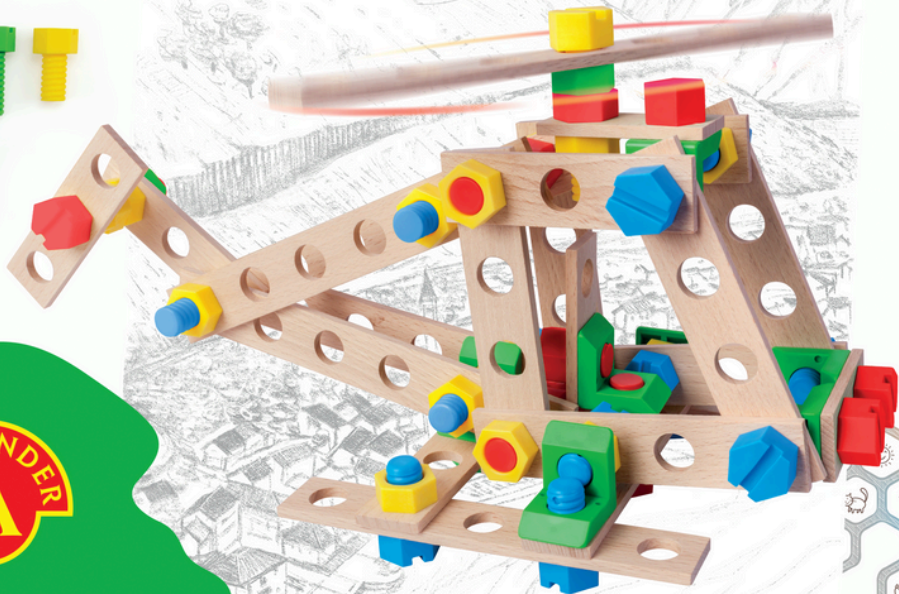

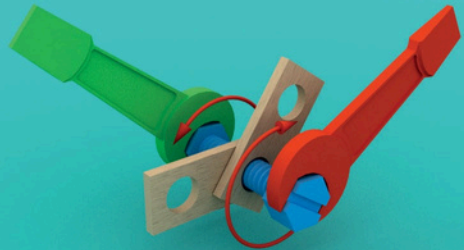
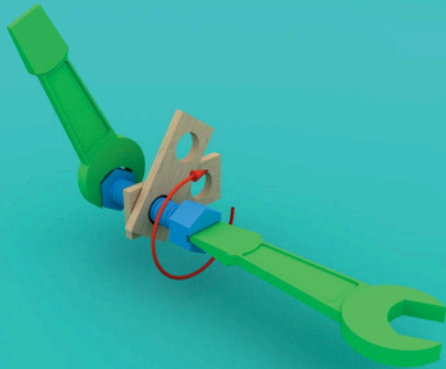

klucz x 2



D02 x 3



D06 x 4



D03 x 4



D04 x 6



D05 x 4



D07 x 1



NP001 x 22



NP001 x 2



NP001 x 1



NP001 x 1



KP001 x 7

13mm



SP001 x 5

24mm



SP004 x 10

33mm



SP002 x 5

54mm



SP003 x 1

54mm

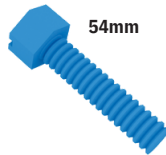





SP003 x 3

54mm



SP003 x 1

-  x 1
-  x 2
-  x 1
-  x 2
-  x 1

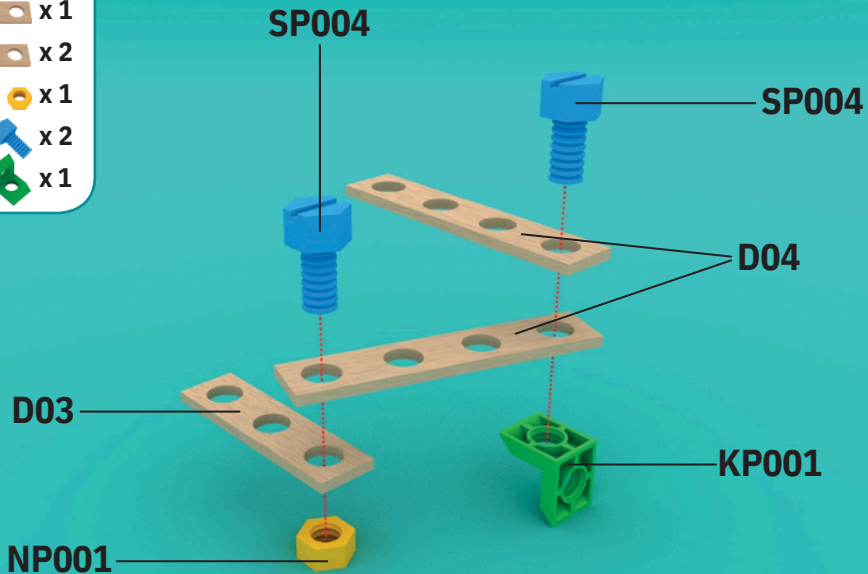

1





NP001

NP001

SP002

D04

D06

-  x 1
-  x 2
-  x 4
-  x 2

x 1

x 2

x 2

x 2

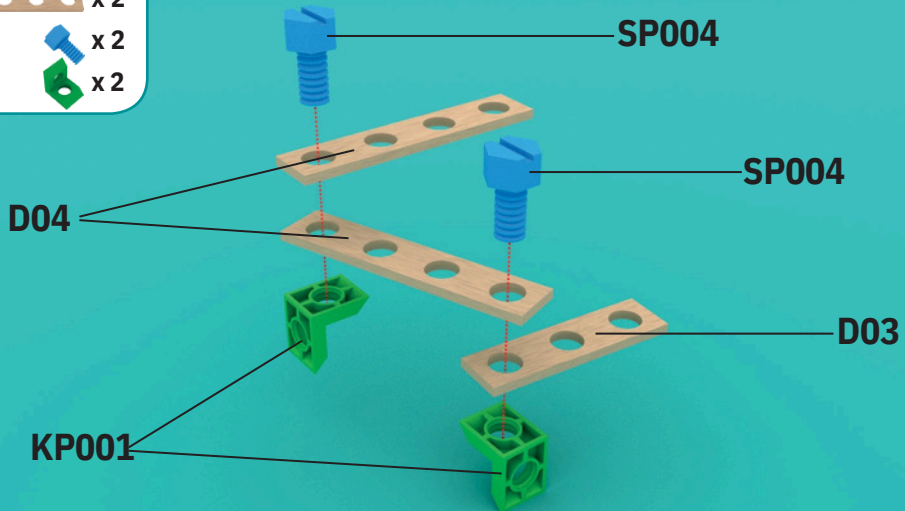

3

NP001

D04

NP001

 x 1

 x 2

 x 4

 x 2

SP0 02

D06

 x1

 x2

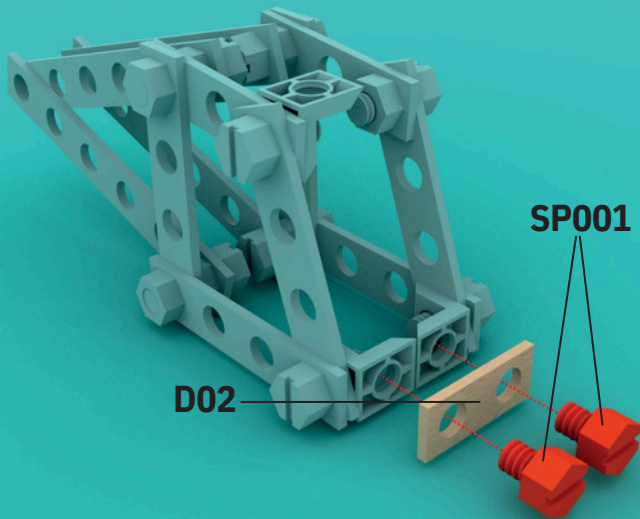





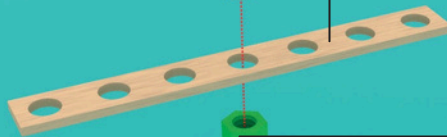

5

SP003

D07



-  x1
-  x1
-  x1
-  x1
-  x1
-  x1

NP001

NP001

NP001

D02

 x1

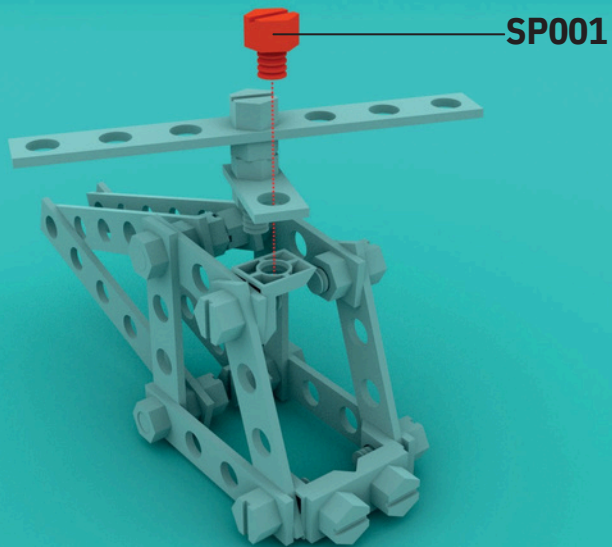

7

SP003



D03

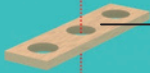

NP001



NP001



D03

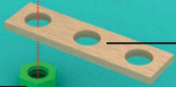

NP001





 x 2

 x 2

 x 1

 x 1

 x 1

 x 2
 x 1

NP001

SP0 03

9

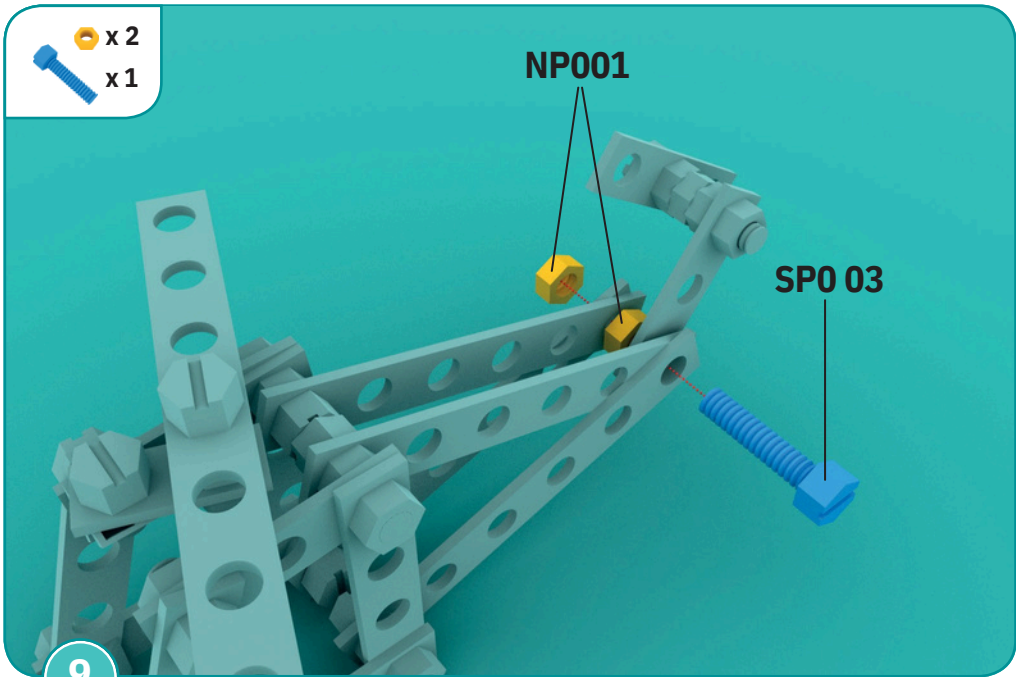



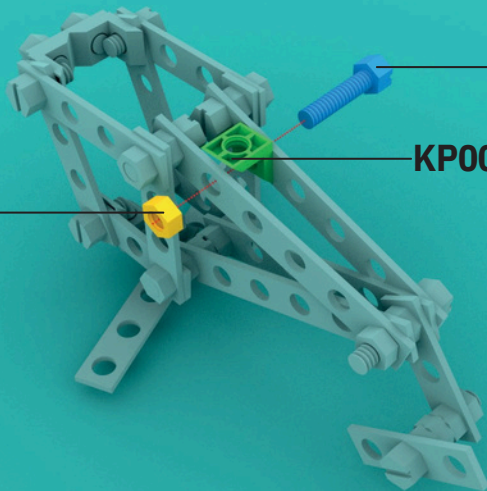

NP001



SP0 03

KP001

-  x1
-  x1
-  x1

 x1
 x1

SP003

NP001

11

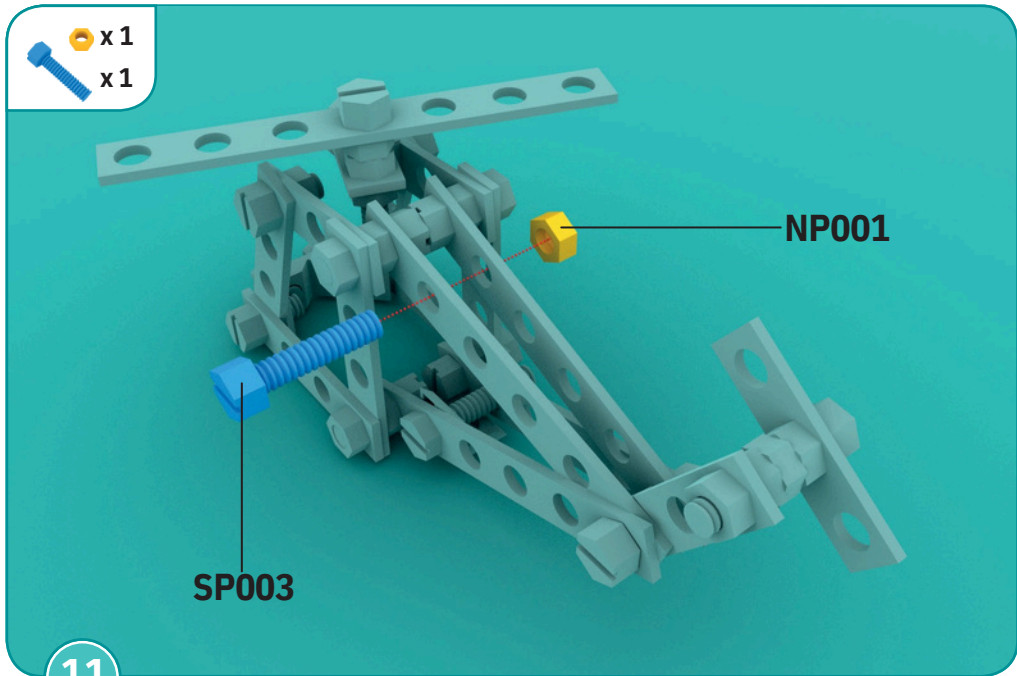





KP001

D05

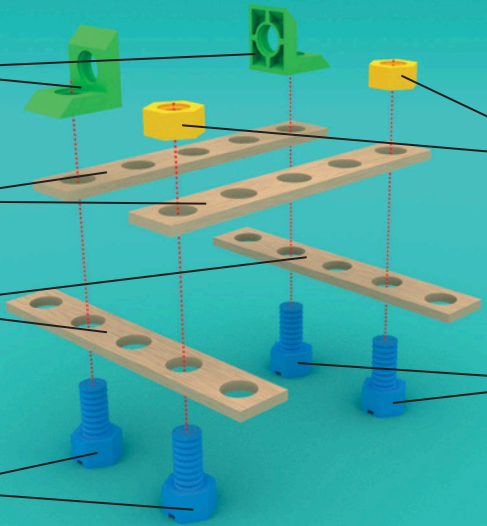
D05

SP004



-  x 4
-  x 2
-  x 4
-  x 2

NP001

SP004

 x1

SP001

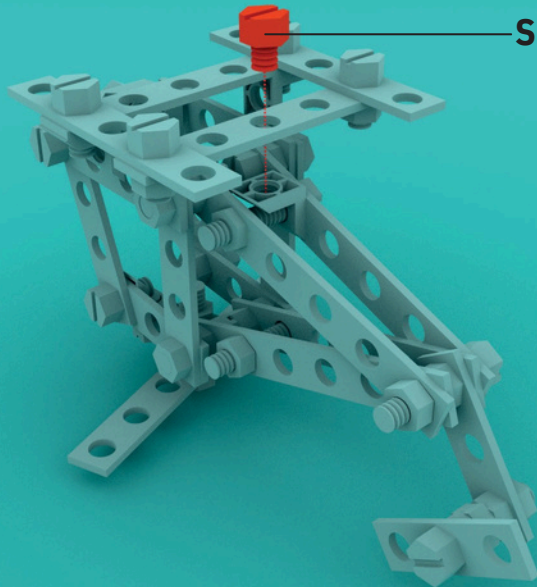

13

-  x 2
-  x 2

NP001

SP004

NP001

 x 1

 x 1

 x 1

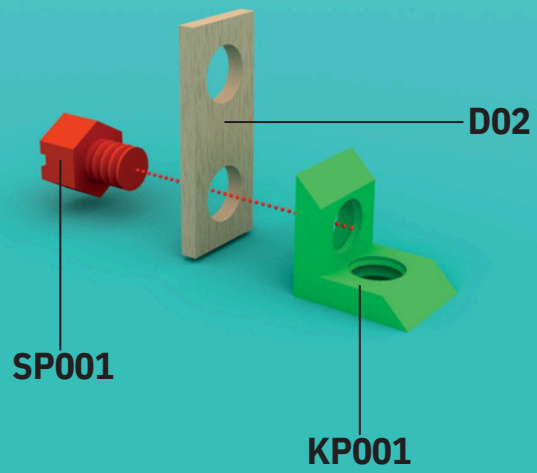

-  x 2
-  x 1

NP001

SP0 02



17

